



TEMAHOME

PURCHASE

Price List

February 2024







INDEX	pages
BOOKCASES	
ALBI BALDA BERLIN DELTA DUBLIN ELLA GROUP LONDON POMBAL STEP VALSA VENICE	1 - 1 1 - 1 1 - 3 4 - 4 4 - 4 5 - 5 5 - 5 5 - 6 6 - 7 8 - 8 8 - 9 9 - 9
COFFEE AND SIDE TABLES	
ALBI BERLIN DETROIT DOURO ELLA GLEAM KLAUS NINA NORA PETRA PRAIRIE SLATE	10 - 10 10 - 10 10 - 10 10 - 10 11 - 11 11 - 13 13 - 13 13 - 13 13 - 13 13 - 14 14 - 14 14 - 14
TV STANDS	
ALBI BERLIN CLIFF JOIN MOVE NARA NINA TRIVIA VERONE	15 - 15 15 - 15 15 - 15 16 - 17 17 - 17 18 - 18 18 - 18 18 - 18 18 - 18

INDEX	pages
SOFAS	
DUNE	19 - 19
SIDEBOARDS	
ALBI EDGE JOIN KOBE NINA VINY	20 - 20 20 - 20 20 - 22 22 - 22 22 - 22 22 - 22
DINING TABLES	
APEX DETROIT DRIFT DUSK LAGO SHADOW	23 - 23 23 - 23 23 - 23 24 - 24 25 - 25 25 - 25
BAR TABLES	
ROLL	26 - 26
DESKS	
CITY DETROIT FLOW FOCUS LIME LOFT MITCH MULTI OLIVAL PLY PRADO TANGO VOLGA	27 - 27 27 - 27 27 - 27 27 - 27 27 - 27 27 - 27 28 - 28 28 - 29 29 - 29 29 - 29 29 - 29 29 - 29 29 - 29
CONSOLES	
BERLIN GLEAM	30 - 30 30 - 30

INDEX	pages
CHAIRS	
SALLY SAND	31 - 31 31 - 31
BEDS	
FLOAT	32 - 34
BEDROOM STORAGE	
AURORA FLOAT HUGO	35 - 35 35 - 35 35 - 36

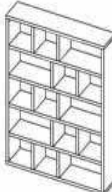

BOOKCASES



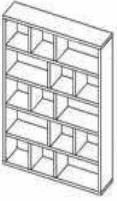
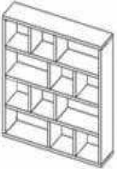
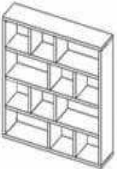
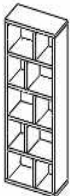

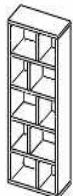
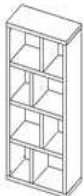
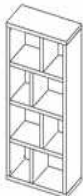

ALBI		finishes	product code	package code	pack. qty	m3	kg	PLN	
ALBI BOOKCASE 120		H 197 cm W 120 cm D 38 cm Kg 49 m3 0,17 pack.qty. 2	WALNUT.VEN/ BLACK METAL	9500.322426	9003.322433	1	0,06	31	3670
					9000.322440	1	0,11	18	
			LIGHT OAK.VEN/ WHITE METAL	9500.322334	9003.322341	1	0,06	31	3670
					9000.322358	1	0,11	18	
		LIGHT OAK.VEN/ BLACK METAL	9500.323645	9003.322341	1	0,06	31	3670	
				9000.322440	1	0,11	18		
		CONCRETE.MEL/ BLACK METAL	9500.323621	9000.323638	1	0,06	29	3670	
				9000.322440	1	0,11	18		
BALDA		finishes	product code	package code	pack. qty	m3	kg	PLN	
BALDA 60		H 5 cm W 60 cm D 22 cm Kg 3 m3 0,01 pack.qty. 1	WALNUT.VEN	9003.991943		0,01	3	280	
			OAK.VEN	9003.991905		0,01	3	280	
			WHITE.LAC	9000.991820		0,01	3	240	
BALDA 90		H 5 cm W 90 cm D 22 cm Kg 4 m3 0,01 pack.qty. 1	WALNUT.VEN	9003.991950		0,01	4	370	
			OAK.VEN	9003.991912		0,01	4	370	
			WHITE.LAC	9000.991837		0,01	4	280	
BALDA 120		H 5 cm W 120 cm D 22 cm Kg 7 m3 0,02 pack.qty. 1	WALNUT.VEN	9003.991967		0,02	7	430	
			OAK.VEN	9003.991929		0,02	7	430	
			WHITE.LAC	9000.991844		0,02	7	350	
BERLIN		finishes	product code	package code	pack. qty	m3	kg	PLN	
BERLIN 150 5 LEVELS		H 198 cm W 150 cm D 34 cm Kg 88 m3 0,38 pack.qty. 3	WALNUT.VEN	9500.318634	9003.318603	1	0,13	32	3520
					9003.318634	1	0,16	33	
					9003.318627	1	0,09	24	
			OAK.VEN	9500.316777	9003.316739	1	0,13	33	3520
					9003.316777	1	0,16	33	
					9003.316753	1	0,09	24	
			WHITE.LAC/ PLYWOOD	9500.318115	9000.318146	1	0,13	31	2810
					9000.318115	1	0,16	31	
					9000.318139	1	0,09	23	
			WHITE.LAC	9500.320729	9000.320668	1	0,13	31	2810
					9000.320675	1	0,16	31	
					9000.320682	1	0,09	23	
BLACK.LAC	9500.322617	9000.322624	1	0,13	31	2940			
		9000.322631	1	0,16	31				
		9000.322648	1	0,09	23				
CONCRETE.MEL	9500.320309	9000.320316	1	0,13	33	2940			
		9000.320323	1	0,16	33				
		9000.320330	1	0,09	24				

BOOKCASES



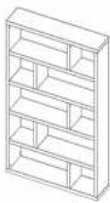

BERLIN		finishes	product code	package code	pack. qty	m3	kg	PLN	
BERLIN BOOKCASE 150 5 LEVELS MIX		H 198 cm W 150 cm D 34 cm Kg 86 m3 0,30 pack.qty. 3	WALNUT.VEN/ BLACK.LAC	9500.324222 9003.324239	1	0,12	37	3420	
					9000.324215	2	0,09	25	
			OAK.VEN/ WHITE.LAC	9500.324178 9003.324185	1	0,12	38	3420	
					9000.324192	2	0,09	25	
		OAK.VEN/ BLACK.LAC	9500.324208 9003.324185	1	0,12	38	3420		
				9000.324215	2	0,09	25		
		CONCRETE.MEL/ BLACK.LAC	9500.324246 9000.324253	1	0,12	37	2940		
				9000.324215	2	0,09	25		
BERLIN 150 4 LEVELS		H 159 cm W 150 cm D 34 cm Kg 70 m3 0,28 pack.qty. 3	WALNUT.VEN	9500.318603 9003.318603	1	0,13	32	2920	
					9003.318610	1	0,05	15	
					9003.318627	1	0,09	24	
			OAK.VEN	9500.316739 9003.316739	1	0,13	33	2920	
					9003.316746	1	0,05	15	
					9003.316753	1	0,09	24	
			WHITE.LAC/ PLYWOOD	9500.318122 9000.318146	1	0,13	31	2340	
					9000.318122	1	0,05	14	
					9000.318139	1	0,09	23	
			WHITE.LAC	9500.320736 9000.320668	1	0,13	31	2340	
					9000.320699	1	0,07	14	
					9000.320682	1	0,09	23	
BLACK.LAC	9500.324024 9000.322624	1	0,13	31	2440				
		9000.324031	1	0,09	17				
		9000.322648	1	0,09	23				
CONCRETE.MEL	9500.322518 9000.320316	1	0,13	33	2440				
		9000.322488	1	0,05	15				
		9000.320330	1	0,09	24				
BERLIN BOOKCASE 150 4 LEVELS MIX		H 159 cm W 150 cm D 34 cm Kg 68 m3 0,21 pack.qty. 2	WALNUT.VEN/ BLACK.LAC	9500.324130 9000.324123	1	0,11	37	2830	
					9003.324147	1	0,10	31	
			OAK.VEN/ WHITE.LAC	9500.324086 9000.324093	1	0,11	37	2830	
					9003.324109	1	0,10	32	
		OAK.VEN/ BLACK.LAC	9500.324116 9000.324123	1	0,11	37	2830		
				9003.324109	1	0,10	32		
		CONCRETE.MEL/ BLACK.LAC	9500.324154 9000.324123	1	0,11	37	2440		
				9000.324161	1	0,10	32		
BERLIN 70 5 LEVELS		H 198 cm W 70 cm D 34 cm Kg 47 m3 0,18 pack.qty. 2	WALNUT.VEN	9500.320200 9003.318641	1	0,08	24	2330	
					9003.320200	1	0,10	23	
			OAK.VEN	9500.320187 9003.316791	1	0,08	25	2330	
					9003.320187	1	0,10	24	
			WHITE.LAC/ PLYWOOD	9500.320217 9000.318108	1	0,08	23	1870	
					9000.320217	1	0,10	22	
			WHITE.LAC	9500.320750 9000.320705	1	0,09	23	1870	
					9000.320712	1	0,11	22	
BLACK.LAC	9500.324062 9000.324055	1	0,08	26	1980				
		9000.324079	1	0,09	26				
CONCRETE.MEL	9500.322525 9000.322495	1	0,08	25	1980				
		9000.322501	1	0,10	24				

BOOKCASES



BERLIN		finishes	product code	package code	pack. qty	m3	kg	PLN	
BERLIN BOOKCASE 70 5 LEVELS MIX		H 198 cm W 70 cm D 34 cm Kg 52 m3 0,17 pack.qty. 2	WALNUT.VEN/ BLACK.LAC	9500.324406	9000.324390	1	0,08	24	2260
					9003.324413	1	0,09	28	
			OAK.VEN/ WHITE.LAC	9500.324352	9000.324369	1	0,08	24	2260
					9003.324376	1	0,09	29	
			OAK.VEN/ BLACK.LAC	9500.324383	9000.324390	1	0,08	24	2260
		9003.324376	1	0,09	29				
		CONCRETE.MEL/ BLACK.LAC	9500.324420	9000.324390	1	0,08	24	1980	
				9000.324437	1	0,09	29		
BERLIN 70 4 LEVELS		H 159 cm W 70 cm D 34 cm Kg 39 m3 0,14 pack.qty. 2	WALNUT.VEN	9500.318641	9003.318641	1	0,08	24	1960
					9003.318610	1	0,05	15	
			OAK.VEN	9500.316791	9003.316791	1	0,08	25	1960
					9003.316746	1	0,05	15	
			WHITE.LAC/ PLYWOOD	9500.318108	9000.318108	1	0,08	23	1570
					9000.318122	1	0,05	14	
			WHITE.LAC	9500.320743	9000.320705	1	0,09	23	1570
		9000.320699	1	0,07	14				
		BLACK.LAC	9500.324048	9000.324055	1	0,08	26	1630	
				9000.324031	1	0,09	17		
		CONCRETE.MEL	9500.322532	9000.322495	1	0,08	25	1630	
				9000.322488	1	0,05	15		
BERLIN BOOKCASE 70 4 LEVELS MIX		H 159 cm W 70 cm D 34 cm Kg 49 m3 0,13 pack.qty. 2	WALNUT.VEN/ BLACK.LAC	9500.324314	9000.324307	1	0,06	25	1890
					9003.324321	1	0,07	25	
			OAK.VEN/ WHITE.LAC	9500.324260	9000.324277	1	0,06	25	1890
					9003.324284	1	0,07	25	
			OAK.VEN/ BLACK.LAC	9500.324291	9000.324307	1	0,06	25	1890
		9003.324284	1	0,07	25				
		CONCRETE.MEL/ BLACK.LAC	9500.324338	9000.324307	1	0,06	25	1630	
				9000.324345	1	0,07	25		
BERLIN BOX		H 34 cm W 34 cm D 33 cm Kg 5 m3 0,02 pack.qty. 1	WHITE.LAC	9000.320651			0,02	5	400
			BLACK.LAC	9000.316678			0,02	5	400
			GREY.LAC	9000.317002			0,02	5	400
			RED.LAC	9000.316685			0,02	5	400

BOOKCASES						
DELTA			finishes	product code	package code	pack. m3 kg PLN qty
DELTA 001		H 195 cm W 76 cm D 30 cm Kg 27 m3 0,09 pack.qty. 2	WHITE.LAC	9500.315305		1270
			BLACK.LAC	9500.315367		1270
DELTA 002		H 195 cm W 97 cm D 30 cm Kg 45 m3 0,14 pack.qty. 3	WHITE.LAC	9500.315350		2240
			BLACK.LAC	9500.315398		2240
DELTA 003		H 195 cm W 170 cm D 30 cm Kg 65 m3 0,20 pack.qty. 4	WHITE.LAC	9500.315312		3230
			BLACK.LAC	9500.315381		3230
DELTA 004		H 195 cm W 190 cm D 30 cm Kg 84 m3 0,25 pack.qty. 5	WHITE.LAC	9500.315336		4200
			BLACK.LAC	9500.315404		4200
DELTA 005		H 195 cm W 263 cm D 30 cm Kg 103 m3 0,31 pack.qty. 6	WHITE.LAC	9500.315343		5190
			BLACK.LAC	9500.315411		5190
DUBLIN			finishes	product code	package code	pack. m3 kg PLN qty
DUBLIN LOW		H 105 cm W 120 cm D 29 cm Kg 26 m3 0,11 pack.qty. 1	MUKALI.VEN	9003.315992		0,11 26 1330
			WHITE.LAC	9000.319860		0,12 26 1330
			CONCRETE.MEL	9000.322600		0,11 24 1330
DUBLIN HIGH		H 173 cm W 120 cm D 29 cm Kg 39 m3 0,17 pack.qty. 1	MUKALI.VEN	9003.315985		0,17 40 1990
			WHITE.LAC	9000.317569		0,19 40 1990
			CONCRETE.MEL	9000.322594		0,19 37 1990

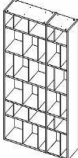
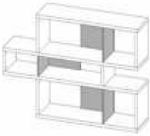



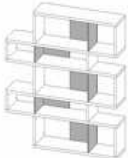

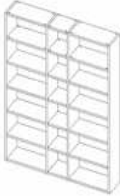
BOOKCASES

BRAND		ELLA		finishes	product code	package code	pack. qty	m3	kg	PLN
ELLA BOOKCASE 40 LOW		H 114 cm W 40 cm D 34 cm Kg 19 m3 0,05 pack.qty. 1	LIGHT OAK.MEL/ WHITE.LAC	9000.323584				0,05	22	900
ELLA BOOKCASE 40 HIGH		H 188 cm W 40 cm D 34 cm Kg 28 m3 0,07 pack.qty. 1	LIGHT OAK.MEL/ WHITE.LAC	9000.323577				0,07	32	1360
ELLA BOOKCASE 90 HIGH		H 188 cm W 90 cm D 34 cm Kg 47 m3 0,13 pack.qty. 2	LIGHT OAK.MEL/ WHITE.LAC	9500.323539	9000.323546 9000.323553		1 1	0,05 0,07	21 26	2050
BRAND		GROUP		finishes	product code	package code	pack. qty	m3	kg	PLN
GROUP 72		H 188 cm W 72 cm D 32 cm Kg 52 m3 0,11 pack.qty. 2	WHITE.LAC/ PLYWOOD	9500.322877	9000.322884 9000.322891		1 1	0,07 0,04	32 21	1780
GROUP 108		H 188 cm W 108 cm D 32 cm Kg 79 m3 0,16 pack.qty. 3	WHITE.LAC/ PLYWOOD	9500.322907	9000.322884 9000.322891 9000.322914		1 1 1	0,07 0,04 0,05	32 21 27	2750
BRAND		LONDON		finishes	product code	package code	pack. qty	m3	kg	PLN
LONDON 001		H 100 cm W 156 cm D 34 cm Kg 34 m3 0,12 pack.qty. 2	WALNUT.VEN OAK.VEN WALNUT.VEN/ WHITE.LAC WALNUT.VEN/ BLACK.LAC OAK.VEN/ WHITE.LAC OAK.VEN/ BLACK.LAC WHITE.LAC/ WALNUT.VEN WHITE.LAC/ OAK.VEN WHITE.LAC WHITE.LAC/ BLACK.LAC	9500.314865 9500.319631 9500.314834 9500.314872 9500.319648 9500.319655 9500.314810 9500.319662 9500.314803 9500.314827						2800 2800 2800 2800 2800 2800 2240 2240 2240 2240



BOOKCASES

LONDON			finishes	product code	package code	pack. qty	m3	kg	PLN
LONDON 002		H 160 cm W 156 cm D 34 cm Kg 56 m3 0,19 pack.qty. 4	WALNUT.VEN	9500.314940					4550
			OAK.VEN	9500.319679					4550
			WALNUT.VEN/ WHITE.LAC	9500.314933					4550
			WALNUT.VEN/ BLACK.LAC	9500.314957					4550
			OAK.VEN/ WHITE.LAC	9500.319686					4550
			OAK.VEN/ BLACK.LAC	9500.319693					4550
			WHITE.LAC/ WALNUT.VEN	9500.314919					3650
			WHITE.LAC/ OAK.VEN	9500.319709					3650
			WHITE.LAC	9500.314902					3650
			WHITE.LAC/ BLACK.LAC	9500.314926					3650
LONDON 003		H 220 cm W 156 cm D 34 cm Kg 78 m3 0,26 pack.qty. 6	WALNUT.VEN	9500.314780					6300
			OAK.VEN	9500.319716					6300
			WALNUT.VEN/ WHITE.LAC	9500.314995					6300
			WALNUT.VEN/ BLACK.LAC	9500.314797					6300
			OAK.VEN/ WHITE.LAC	9500.319723					6300
			OAK.VEN/ BLACK.LAC	9500.319730					6300
			WHITE.LAC/ WALNUT.VEN	9500.314971					5060
			WHITE.LAC/ OAK.VEN	9500.319747					5060
			WHITE.LAC	9500.314964					5060
			WHITE.LAC/ BLACK.LAC	9500.314988					5060
POMBAL			finishes	product code	package code	pack. qty	m3	kg	PLN
COMP. POMBAL 2010-001		H 224 cm W 151 cm D 34 cm Kg 80 m3 0,37 pack.qty. 4	WALNUT.VEN	9500.510403	9003.948312	1	0,11	26	5850
					9003.948329	3	0,09	18	
			OAK.VEN	9500.515897	9003.319105	1	0,11	26	5850
					9003.319112	3	0,09	18	
			WHITE.LAC	9500.510872	9000.310607	1	0,11	24	5850
					9000.310614	3	0,09	18	
COMP. POMBAL 2010-018		H 224 cm W 181 cm D 34 cm Kg 80 m3 0,33 pack.qty. 3	WALNUT.VEN	9500.515262	9003.948336	1	0,14	35	5770
					9003.948329	1	0,09	18	
					9003.948343	1	0,11	28	
			OAK.VEN	9500.515941	9003.319129	1	0,14	35	5770
					9003.319112	1	0,09	18	
					9003.319136	1	0,11	28	
			WHITE.LAC	9500.515248	9000.310621	1	0,14	33	5770
					9000.310614	1	0,09	18	
					9000.310638	1	0,11	27	
			CONCRETE.MEL	9500.516283	9000.319457	1	0,14	33	4640
					9000.319655	1	0,09	17	
					9000.319464	1	0,11	26	

BOOKCASES



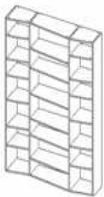
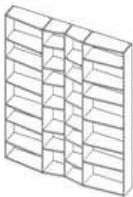
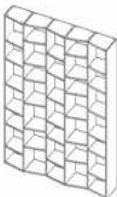

POMBAL		finishes	product code	package code	pack. qty	m3	kg	PLN
COMP POMBAL 2012-055		H 224 cm W 255 cm D 34 cm Kg 117 m3 0,51 pack.qty. 5	WALNUT.VEN	9500.317811 9003.948312	1	0,11	26	8470
				9003.948329	2	0,09	18	
				9003.948343	2	0,11	28	
			OAK.VEN	9500.515934 9003.319105	1	0,11	26	8470
				9003.319112	2	0,09	18	
				9003.319136	2	0,11	28	
			WHITE.LAC	9500.317835 9000.310607	1	0,11	24	8470
				9000.310614	2	0,09	18	
				9000.310638	2	0,11	27	
			CONCRETE.MEL	9500.516290 9000.319648	1	0,11	24	6790
				9000.319655	2	0,09	17	
				9000.319464	2	0,11	26	
KIT A 224 x 40 CM		H 224 cm W 40 cm D 34 cm Kg 25 m3 0,11 pack.qty. 1	WALNUT.VEN	9003.948312		0,11	26	1890
				OAK.VEN	9003.319105		0,11	26
			WHITE.LAC	9000.310607		0,11	24	1890
				CONCRETE.MEL	9000.319648		0,11	24
KIT A 224 x 74 CM		H 224 cm W 74 cm D 34 cm Kg 34 m3 0,14 pack.qty. 1	WALNUT.VEN	9003.948336		0,14	35	2480
				OAK.VEN	9003.319129		0,14	35
			WHITE.LAC	9000.310621		0,14	33	2480
				CONCRETE.MEL	9000.319457		0,14	33
KIT B 224 x 37 CM		H 224 cm W 37 cm D 34 cm Kg 18 m3 0,09 pack.qty. 1	WALNUT.VEN	9003.948329		0,09	18	1320
				OAK.VEN	9003.319112		0,09	18
			WHITE.LAC	9000.310614		0,09	18	1320
				CONCRETE.MEL	9000.319655		0,09	17
KIT B 224 x 71 CM		H 224 cm W 71 cm D 34 cm Kg 31 m3 0,11 pack.qty. 1	WALNUT.VEN	9003.948343		0,11	28	1970
				OAK.VEN	9003.319136		0,11	28
			WHITE.LAC	9000.310638		0,11	27	1970
				CONCRETE.MEL	9000.319464		0,11	26
DRAWER UNIT (68 CM)		H 34 cm W 68 cm D 34 cm Kg 19 m3 0,09 pack.qty. 1	WHITE.LAC	9000.311390		0,09	19	1420
BERLIN BOX		H 34 cm W 34 cm D 33 cm Kg 5 m3 0,02 pack.qty. 1	WHITE.LAC	9000.320651		0,02	5	400
			BLACK.LAC	9000.316678		0,02	5	400
			GREY.LAC	9000.317002		0,02	5	400
			RED.LAC	9000.316685		0,02	5	400

BOOKCASES

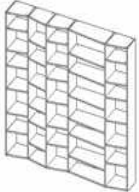
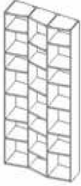
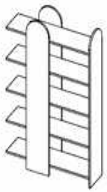

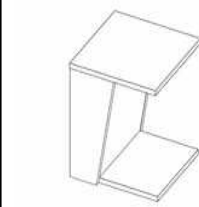
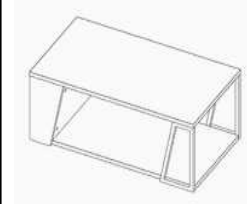
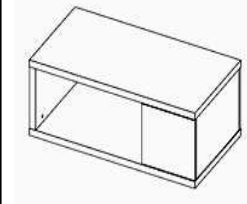

STEP			finishes	product code	package code	pack. qty	m3	kg	PLN
STEP LOW		H 88 cm W 163 cm D 36 cm Kg 41 m3 0,14 pack.qty. 1	WHITE.LAC	9000.273254			0,14	41	1520
			WALNUT.MEL/ BLACK.LAC	9000.323669			0,14	41	2000
			CONCRETE.MEL/ BLACK.LAC	9000.320224			0,14	37	1740
STEP HIGH		H 172 cm W 163 cm D 36 cm Kg 72 m3 0,24 pack.qty. 2	WHITE.LAC	9500.273261	9000.273254	1	0,14	41	2730
					9000.273261	1	0,10	32	
			WALNUT.MEL/ BLACK.LAC	9500.323676	9000.323669	1	0,14	41	3550
				9000.323782	1	0,10	32		
			CONCRETE.MEL/ BLACK.LAC	9500.273278	9000.320224	1	0,14	37	3120
					9000.273278	1	0,10	29	
VALSA			finishes	product code	package code	pack. qty	m3	kg	PLN
VALSA 001		H 224 cm W 108 cm D 34 cm Kg 58 m3 0,15 pack.qty. 3	WHITE.LAC	9500.316562	9000.316586	1	0,06	21	2750
					9000.316616	1	0,07	29	
					9000.316647	1	0,02	9	
			GREY.LAC	9500.316395	9000.316487	1	0,06	22	2750
					9000.316517	1	0,07	29	
				9000.316548	1	0,02	9		
VALSA 002		H 224 cm W 144 cm D 34 cm Kg 77 m3 0,20 pack.qty. 4	WHITE.LAC	9500.316579	9000.316586	1	0,06	21	3670
					9000.316616	1	0,07	29	
					9000.316623	1	0,06	20	
					9000.316654	1	0,02	7	
			GREY.LAC	9500.316487	9000.316487	1	0,06	22	3670
				9000.316517	1	0,07	29		
				9000.316524	1	0,06	21		
				9000.316555	1	0,02	8		
VALSA 003		H 224 cm W 214 cm D 34 cm Kg 105 m3 0,27 pack.qty. 5	WHITE.LAC	9500.316586	9000.316579	1	0,07	29	5010
					9000.316623	1	0,06	20	
					9000.316609	1	0,06	19	
					9000.316630	1	0,07	30	
					9000.316654	1	0,02	7	
			GREY.LAC	9500.316494	9000.316395	1	0,07	30	5010
					9000.316524	1	0,06	21	
		9000.316500	1	0,06	19				
				9000.316531	1	0,07	31		
				9000.316555	1	0,02	8		
VALSA 004		H 224 cm W 182 cm D 34 cm Kg 106 m3 0,30 pack.qty. 6	WHITE.LAC	9500.316500	9000.316562	1	0,06	20	5040
					9000.316623	2	0,06	20	
					9000.316609	2	0,06	19	
					9000.316647	1	0,02	9	
			GREY.LAC	9500.316388	9000.316388	1	0,06	20	5040
					9000.316524	2	0,06	21	
					9000.316500	2	0,06	19	
				9000.316548	1	0,02	9		

BOOKCASES







VALSA			finishes	product code	package code	pack. qty	m3	kg	PLN
VALSA 005		H 224 cm W 216 cm D 34 cm Kg 116 m3 0,31 pack.qty. 6	WHITE.LAC	9500.316609	9000.316586	1	0,06	21	5400
					9000.316609	1	0,06	19	
					9000.316623	2	0,06	20	
					9000.316616	1	0,07	29	
					9000.316654	1	0,02	7	
			GREY.LAC	9500.316517	9000.316487	1	0,06	22	5400
					9000.316500	1	0,06	19	
					9000.316524	2	0,06	21	
					9000.316517	1	0,07	29	
					9000.316555	1	0,02	8	
VALSA 007		H 224 cm W 110 cm D 27/34 cm Kg 67 m3 0,19 pack.qty. 4	WHITE.LAC	9500.316647	9000.316586	1	0,06	21	3100
					9000.316609	1	0,06	19	
					9000.316623	1	0,06	20	
					9000.316654	1	0,02	7	
			GREY.LAC	9500.316555	9000.316487	1	0,06	22	3100
					9000.316500	1	0,06	19	
					9000.316524	1	0,06	21	
					9000.316555	1	0,02	8	
VENICE BOOKCASE		H 175 cm W 112 cm D 34 cm Kg 49 m3 0,09 pack.qty. 2	LIGHT OAK.VEN	9500.323591	9003.323607	1	0,05	25	1890
					9003.323614	1	0,05	25	
			CONCRETE.MEL/ BLACK.LAC	9500.323652	9000.323683	1	0,05	23	1890
					9000.323690	1	0,05	23	

COFFEE AND SIDE TABLES								
ALBI		finishes	product code	package code	pack. qty	m3	kg	PLN
ALBI SIDE TABLE		H 46 cm	WALNUT.VEN/ BLACK.LAC	9003.629907		0,02	10	480
		W 40 cm	LIGHT OAK.VEN/ WHITE.LAC	9003.629914		0,02	10	480
		D 40 cm	LIGHT OAK.VEN/ BLACK.LAC	9003.630804		0,02	10	480
		Kg 9	CONCRETE.MEL/ BLACK.LAC	9000.630781		0,02	9	480
m3 0,02								
pack.qty. 1								
ALBI COFFEE TABLE		H 36 cm	WALNUT.VEN/ BLACK METAL	9003.629921		0,04	22	1710
		W 100 cm	LIGHT OAK.VEN/ WHITE METAL	9003.629938		0,04	23	1710
		D 55 cm	LIGHT OAK.VEN/ BLACK METAL	9003.630811		0,04	22	1710
		Kg 21	CONCRETE.MEL/ BLACK METAL	9000.630798		0,04	21	1710
m3 0,04								
pack.qty. 1								
BERLIN		finishes	product code	package code	pack. qty	m3	kg	PLN
BERLIN COFFEE TABLE		H 44 cm	WALNUT.VEN/ BLACK.LAC	9003.630743		0,09	29	1290
		W 105 cm	OAK.VEN/ WHITE.LAC	9003.630736		0,09	29	1290
		D 55 cm	WHITE.LAC/ PLYWOOD	9000.630729		0,09	28	1130
		Kg 26	WHITE.LAC	9000.630712		0,09	28	1130
		m3 0,09	CONCRETE.MEL/ BLACK.LAC	9000.630750		0,09	29	1190
pack.qty. 1								
DETROIT		finishes	product code	package code	pack. qty	m3	kg	PLN
DETROIT COFFEE TABLE		H 29 cm	CONCRETE.MEL/ BLACK.LAC	9000.625039		0,16	26	1420
		W 110 cm						
		D 65 cm						
		Kg 25						
		m3 0,16						
pack.qty. 1								
DOURO		finishes	product code	package code	pack. qty	m3	kg	PLN
DOURO COFFEE TABLE 120 W/ 3 TOPS AND 2 BOXES		H 45 cm	LIGHT OAK.MEL/ BLACK.LAC	9000.630910		0,07	26	2890
		W 120 cm						
		D 75 cm						
		Kg 28						
		m3 0,07						
pack.qty. 1								
DOURO COFFEE TABLE 120 W/4 TOPS		H 40 cm	LIGHT OAK.MEL/ BLACK.LAC	9000.630927		0,07	27	2290
		W 120 cm						
		D 75 cm						
		Kg 28						
		m3 0,07						
pack.qty. 1								





COFFEE AND SIDE TABLES

BRAND		ELLA		finishes	product code	package code	pack. qty	m3	kg	PLN
ELLA SIDE TABLE 40		H 47 cm W 40 cm D 40 cm Kg 13 m3 0,03 pack.qty. 1	LIGHT OAK.MEL/ WHITE.LAC	9000.630767				0,03	14	49
ELLA SIDE TABLE 70		H 47 cm W 70 cm D 40 cm Kg 21 m3 0,04 pack.qty. 1	LIGHT OAK.MEL/ WHITE.LAC	9000.630774				0,04	19	60
BRAND		GLEAM		finishes	product code	package code	pack. qty	m3	kg	PLN
GLEAM 50 MARBLE		H 45 cm W 50 cm D 50 cm Kg 20 m3 0,18 pack.qty. 2	WHITE MARBLE/ CHROME METAL	9500.626081	9000.623004	1	0,05	16	2210	
					9000.626036	1	0,13	5		
			BLACK MARBLE/ CHROME METAL	9500.626074	9000.623011	1	0,05	16	2210	
					9000.626036	1	0,13	5		
			GREEN MARBLE/ CHROME METAL	9500.626449	9000.625923	1	0,05	16	2210	
					9000.626036	1	0,13	5		
			WHITE MARBLE/ BLACK METAL	9500.625985	9000.623004	1	0,05	16	1870	
		9000.625947	1	0,13	5					
GLEAM 50 MARBLE KIT		H 45 cm W 50 cm D 50 cm Kg 19 m3 0,08 pack.qty. 2	WHITE MARBLE/ BLACK METAL	9500.630064	9000.623004	1	0,05	16	1770	
					9000.629983	1	0,03	3		
			BLACK MARBLE/ BLACK METAL	9500.630088	9000.623011	1	0,05	16	1770	
		9000.629983	1	0,03	3					
GLEAM 50		H 45 cm W 50 cm D 50 cm Kg 8 m3 0,14 pack.qty. 2	WALNUT.VEN/ CHROME METAL	9500.629020	9003.628740	1	0,01	4	1490	
					9000.626036	1	0,13	5		
			WALNUT.VEN/ BLACK METAL	9500.628788	9003.628740	1	0,01	4	1150	
					9000.625947	1	0,13	5		
		OAK.VEN/ CHROME METAL	9500.626593	9003.626470	1	0,01	4	1490		
				9000.626036	1	0,13	5			
		OAK.VEN/ BLACK METAL	9500.626562	9003.626470	1	0,01	4	1150		
				9000.625947	1	0,13	5			

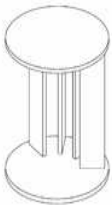

COFFEE AND SIDE TABLES

GLEAM		finishes	product code	package code	pack. qty	m3	kg	PLN	
GLEAM 75 MARBLE		H 40 cm W 75 cm D 75 cm Kg 44 m3 0,34 pack.qty. 2	WHITE MARBLE/ CHROME METAL	9500.626210	9000.623066	1	0,11	40	3280
					9000.626043	1	0,23	5	
			BLACK MARBLE/ CHROME METAL	9500.626203	9000.623073	1	0,11	40	3280
					9000.626043	1	0,23	5	
			GREEN MARBLE/ CHROME METAL	9500.626227	9000.626067	1	0,11	40	3280
					9000.626043	1	0,23	5	
GLEAM 75 MARBLE KIT		H 40 cm W 75 cm D 75 cm Kg 44 m3 0,18 pack.qty. 2	WHITE MARBLE/ BLACK METAL	9500.630125	9000.623066	1	0,11	40	2710
					9000.630002	1	0,07	5	
			BLACK MARBLE/ BLACK METAL	9500.630149	9000.623073	1	0,11	40	2710
					9000.630002	1	0,07	5	
			GREEN MARBLE/ BLACK METAL	9500.630163	9000.626067	1	0,11	40	2710
					9000.630002	1	0,07	5	
GLEAM 75		H 40 cm W 75 cm D 75 cm Kg 13 m3 0,25 pack.qty. 2	WALNUT.VEN/ CHROME METAL	9500.629037	9003.628757	1	0,02	9	1840
					9000.626043	1	0,23	5	
			WALNUT.VEN/ BLACK METAL	9500.628795	9003.628757	1	0,02	9	1400
					9000.625961	1	0,23	6	
GLEAM 75		H 40 cm W 75 cm D 75 cm Kg 13 m3 0,25 pack.qty. 2	OAK.VEN/ CHROME METAL	9500.626630	9003.626494	1	0,02	8	1840
					9000.626043	1	0,23	5	
			OAK.VEN/ BLACK METAL	9500.626609	9003.626494	1	0,02	8	1400
					9000.625961	1	0,23	6	
GLEAM 120 MARBLE		H 40 cm W 120 cm D 75 cm Kg 69 m3 0,53 pack.qty. 2	WHITE MARBLE/ CHROME METAL	9500.626456	9000.623080	1	0,16	64	4770
					9000.626050	1	0,36	6	
			BLACK MARBLE/ CHROME METAL	9500.626098	9000.623097	1	0,16	64	4770
					9000.626050	1	0,36	6	
			GREEN MARBLE/ CHROME METAL	9500.626104	9000.625930	1	0,16	64	4770
					9000.626050	1	0,36	6	
GLEAM 120 MARBLE KIT		H 40 cm W 120 cm D 75 cm Kg 70 m3 0,27 pack.qty. 2	WHITE MARBLE/ BLACK METAL	9500.630187	9000.623080	1	0,16	64	4040
					9000.630026	1	0,11	7	
			BLACK MARBLE/ BLACK METAL	9500.630200	9000.623097	1	0,16	64	4040
					9000.630026	1	0,11	7	
			GREEN MARBLE/ BLACK METAL	9500.630224	9000.625930	1	0,16	64	4040
					9000.630026	1	0,11	7	

COFFEE AND SIDE TABLES

GLEAM			finishes	product code	package code	pack. qty	m3	kg	PLN
GLEAM 120		H 40 cm W 120 cm D 75 cm Kg 19 m3 0,40 pack.qty. 2	WALNUT.VEN/ CHROME METAL	9500.629044	9003.628764	1	0,03	13	2520
					9000.626050	1	0,36	6	
			WALNUT.VEN/ BLACK METAL	9500.628801	9003.628764	1	0,03	13	1970
					9000.625954	1	0,36	6	
			OAK.VEN/ CHROME METAL	9500.626678	9003.626524	1	0,03	13	2520
					9000.626050	1	0,36	6	
			OAK.VEN/ BLACK METAL	9500.626647	9003.626524	1	0,03	13	1970
					9000.625954	1	0,36	6	
KLAUS			finishes	product code	package code	pack. qty	m3	kg	PLN
KLAUS SIDE TABLE		H 55 cm W 38 cm D 45 cm Kg 13 m3 0,05 pack.qty. 1	WALNUT.MEL/ BLACK.LAC	9000.630842			0,05	13	700
			CONCRETE.MEL/ BLACK.LAC	9000.627804			0,05	13	640
NINA			finishes	product code	package code	pack. qty	m3	kg	PLN
NINA COFFEE TABLE		H 45 cm W 100 cm D 55 cm Kg 26 m3 0,08 pack.qty. 1	WALNUT.VEN/ BLACK.LAC	9003.630903			0,08	25	1660
			LIGHT OAK.VEN/ WHITE.LAC	9003.629952			0,08	26	1660
			LIGHT OAK.VEN/ BLACK.LAC	9003.629945			0,08	26	1660
NORA			finishes	product code	package code	pack. qty	m3	kg	PLN
NORA SOFA TABLE		H 64 cm W 50 cm D 50 cm Kg 11 m3 0,03 pack.qty. 1	WALNUT.VEN	9003.629969			0,03	11	720
			LIGHT OAK.VEN	9003.630651			0,03	11	720
NORA COFFEE TABLE		H 51 cm W 110 cm D 50 cm Kg 21 m3 0,05 pack.qty. 1	WALNUT.VEN	9003.630644			0,05	24	1070
			LIGHT OAK.VEN	9003.630668			0,05	25	1070
PETRA			finishes	product code	package code	pack. qty	m3	kg	PLN
PETRA SIDE TABLE 50		H 53 cm W 50 cm D 50 cm Kg 10 m3 0,05 pack.qty. 1	CONCRETE.MEL/ BLACK METAL	9000.630934			0,05	10	1090

COFFEE AND SIDE TABLES

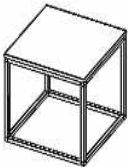
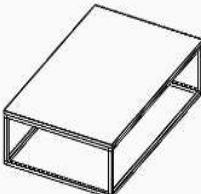
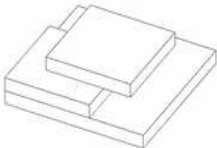
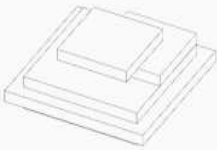
PETRA			finishes	product code	package code	pack. qty	m3	kg	PLN
PETRA SIDE TABLE 55		H 53 cm W 55 cm D 55 cm Kg 13 m3 0,06 pack.qty. 1	CONCRETE.MEL/ BLACK METAL	9000.629341			0,06	14	1130
PETRA COFFEE TABLE 75		H 38 cm W 75 cm D 75 cm Kg 16 m3 0,10 pack.qty. 1	CONCRETE.MEL/ BLACK METAL	9000.629358			0,10	17	1240
PETRA COFFEE TABLE 120		H 38 cm W 120 cm D 75 cm Kg 22 m3 0,15 pack.qty. 1	CONCRETE.MEL/ BLACK METAL	9000.629365			0,15	23	1330
PRAIRIE			finishes	product code	package code	pack. qty	m3	kg	PLN
PRAIRIE 50 MARBLE		H 47 cm W 50 cm D 50 cm Kg 19 m3 0,07 pack.qty. 2	WHITE MARBLE/ CHROME METAL	9500.625053	9000.623004	1	0,05	16	1820
					9000.623820	1	0,02	4	
			BLACK MARBLE/ CHROME METAL	9500.625022	9000.623011	1	0,05	16	1820
					9000.623820	1	0,02	4	
			WHITE MARBLE/ BLACK METAL	9500.625015	9000.623004	1	0,05	16	1530
		9000.312519	1	0,02	4				
PRAIRIE 120 MARBLE		H 32 cm W 120 cm D 75 cm Kg 73 m3 0,22 pack.qty. 2	WHITE MARBLE/ CHROME METAL	9500.624919	9000.623080	1	0,16	64	4250
					9000.623875	1	0,06	10	
			BLACK MARBLE/ CHROME METAL	9500.624926	9000.623097	1	0,16	64	4250
					9000.623875	1	0,06	10	
			WHITE MARBLE/ BLACK METAL	9500.625046	9000.623080	1	0,16	64	3750
		9000.312663	1	0,06	10				
		BLACK MARBLE/ BLACK METAL	9500.623097	9000.623097	1	0,16	64	3750	
		9000.312663	1	0,06	10				
SLATE			finishes	product code	package code	pack. qty	m3	kg	PLN
SLATE COFFEE TABLE 90		H 30 cm W 90 cm D 90 cm Kg 45 m3 0,24 pack.qty. 2	WHITE.LAC/ OAK.VEN	9500.625237	9000.311987	1	0,07	17	2120
					9003.625237	1	0,17	28	
			WHITE.LAC	9500.311819	9000.311987	1	0,07	17	2120
					9000.311819	1	0,17	28	
		CONCRETE.MEL/ BLACK.LAC	9500.627132	9000.627149	1	0,07	17	1700	
		9000.627156	1	0,17	28				
SLATE COFFEE TABLE 110		H 37 cm W 110 cm D 110 cm Kg 82 m3 0,33 pack.qty. 3	WALNUT.MEL/ BLACK.LAC	9500.630859	9000.630866	1	0,06	19	2820
					9000.630873	1	0,15	41	
					9000.630880	1	0,12	29	
			CONCRETE.MEL/ BLACK.LAC	9500.630675	9000.630682	1	0,06	18	2500
		9000.630699	1	0,15	40				
		9000.630705	1	0,12	28				



BRAND

SLATE

SLATE COFFEE TABLE 90

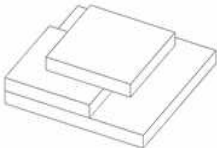
H 30 cm
W 90 cm
D 90 cm
Kg 45
m3 0,24
pack.qty. 2WHITE.LAC/
OAK.VEN

9500.625237 9000.311987

1 0,07 17 2120

WHITE.LAC

9500.311819 9000.311987

1 0,07 17 2120

CONCRETE.MEL/
BLACK.LAC

9500.627132 9000.627149

1 0,07 17 1700

SLATE COFFEE TABLE 110

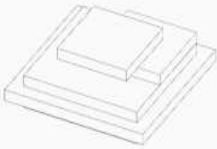
H 37 cm
W 110 cm
D 110 cm
Kg 82
m3 0,33
pack.qty. 3WALNUT.MEL/
BLACK.LAC

9500.630859 9000.630866



1 0,06 19 2820





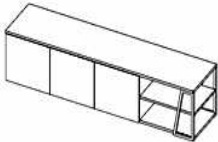
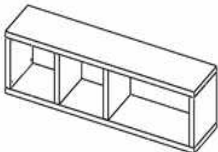

CONCRETE.MEL/
BLACK.LAC

9500.630675 9000.630682

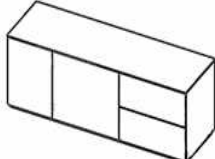
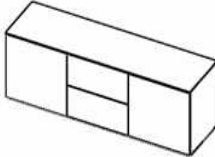
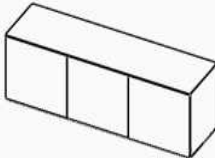

1 0,06 18 2500



TV STANDS

ALBI		finishes	product code	package code	pack. qty	m3	kg	PLN		
ALBI TV STAND 145		H 45 cm W 145 cm D 45 cm Kg 43 m3 0,10 pack.qty. 2	WALNUT.VEN/ BLACK METAL	9500.639791	9003.639807	1	0,07	33	2820	
					9000.639814	1	0,03	10		
			LIGHT OAK.VEN/ WHITE METAL	9500.639821	9003.639838	1	0,07	34	2820	
					9000.639845	1	0,03	10		
			LIGHT OAK.VEN/ BLACK METAL	9500.640032	9003.639838	1	0,07	34	2820	
		9000.639814	1	0,03	10					
		CONCRETE.MEL/ BLACK METAL	9500.639982	9000.639999	1	0,07	31	2820		
				9000.639814	1	0,03	10			
ALBI TV STAND 190		H 45 cm W 190 cm D 45 cm Kg 56 m3 0,13 pack.qty. 2	WALNUT.VEN/ BLACK METAL	9500.639876	9003.639883	1	0,08	37	3390	
					9003.639890	1	0,05	19		
			LIGHT OAK.VEN/ WHITE METAL	9500.639869	9003.639906	1	0,08	38	3390	
					9003.639913	1	0,05	19		
			LIGHT OAK.VEN/ BLACK METAL	9500.640049	9003.640056	1	0,08	37	3390	
		9003.640063	1	0,05	19					
		CONCRETE.MEL/ BLACK METAL	9500.640001	9000.640018	1	0,08	36	3390		
				9000.640025	1	0,05	18			
BERLIN		finishes	product code	package code	pack. qty	m3	kg	PLN		
BERLIN TV STAND 150		H 45 cm W 150 cm D 34 cm Kg 22 m3 0,07 pack.qty. 1	WALNUT.VEN	9003.639753			0,07	22	1520	
			OAK.VEN	9003.639746				0,07	23	1520
			WHITE.LAC/ PLYWOOD	9000.639739				0,07	21	1200
			WHITE.LAC	9000.639722				0,07	21	1200
			CONCRETE.MEL	9000.639760				0,07	23	1200
CLIFF		finishes	product code	package code	pack. qty	m3	kg	PLN		
CLIFF 120/120		H 20/40 cm W 125/235 cm D 38 cm Kg 23 m3 0,11 pack.qty. 1	WHITE.LAC	9000.639265			0,11	23	1120	
			CONCRETE.MEL/ BLACK.LAC	9000.639579				0,11	24	1120

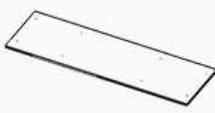
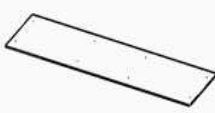
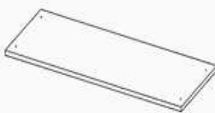
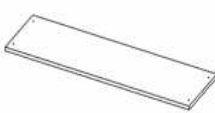

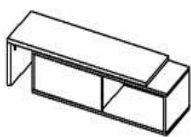

TV STANDS						
JOIN		finishes	product code	package code	pack. m3 kg	PLN qty
JOIN 160L2 - BASE		H 57 cm W 160 cm D 50 cm Kg 76 m3 0,25 pack.qty. 5	WHITE.LAC/ WALNUT.VEN	9500.404641		3680
			WHITE.LAC/ OAK.VEN	9500.404634		3680
			WHITE.LAC	9500.404627		3680
JOIN 180L1 - BASE		H 57 cm W 180 cm D 50 cm Kg 83 m3 0,27 pack.qty. 5	WHITE.LAC/ WALNUT.VEN	9500.405235		3830
			WHITE.LAC/ OAK.VEN	9500.405228		3830
			WHITE.LAC	9500.405266		3830
JOIN 180L2 - BASE		H 57 cm W 180 cm D 50 cm Kg 79 m3 0,26 pack.qty. 5	WHITE.LAC/ WALNUT.VEN	9500.405334		3300
			WHITE.LAC/ OAK.VEN	9500.405327		3300
			WHITE.LAC	9500.405365		3300
KIT A 120 LOW JOIN 2 DOORS		H 53 cm W 120 cm D 49 cm Kg 41 m3 0,10 pack.qty. 2	WHITE.LAC	9500.403378		1600
KIT A 120 LOW JOIN 1 DOOR + 2 DRAWERS		H 53 cm W 120 cm D 49 cm Kg 44 m3 0,12 pack.qty. 2	WHITE.LAC	9500.403255		2130
KIT A 120 LOW JOIN 4 DRAWERS		H 53 cm W 120 cm D 49 cm Kg 47 m3 0,12 pack.qty. 2	WHITE.LAC	9500.403385		2640
KIT B 60 LOW JOIN 1 DOOR		H 53 cm W 60 cm D 49 cm Kg 19 m3 0,05 pack.qty. 1	WHITE.LAC	9000.403125	0,05 19	770
KIT B 40 LOW JOIN 1 DOOR		H 53 cm W 41 cm D 49 cm Kg 14 m3 0,04 pack.qty. 1	WHITE.LAC	9000.403316	0,04 15	660

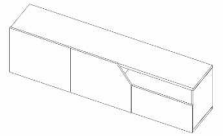



TV STANDS

JOIN			finishes	product code	package code	pack. qty	m3	kg	PLN
TOP 120 JOIN		H 1 cm W 120 cm D 50 cm Kg 7 m3 0,03 pack.qty. 1	WALNUT.VEN	9003.403712			0,03	8	400
			OAK.VEN	9003.403668			0,03	8	400
			WHITE.LAC	9000.403767			0,03	7	400
TOP 160 JOIN		H 1 cm W 160 cm D 50 cm Kg 10 m3 0,04 pack.qty. 1	WALNUT.VEN	9003.403729			0,04	10	460
			OAK.VEN	9003.403675			0,04	10	460
			WHITE.LAC	9000.403774			0,04	9	460
TOP 180 JOIN		H 1 cm W 180 cm D 50 cm Kg 10 m3 0,05 pack.qty. 1	WALNUT.VEN	9003.403736			0,05	11	490
			OAK.VEN	9003.403682			0,05	11	490
			WHITE.LAC	9000.403781			0,05	10	490
BASE 120 JOIN		H 3 cm W 118 cm D 45 cm Kg 5 m3 0,04 pack.qty. 1	WHITE.LAC	9000.403965			0,04	6	370
BASE 160 JOIN		H 3 cm W 158 cm D 45 cm Kg 7 m3 0,05 pack.qty. 1	WHITE.LAC	9000.403972			0,05	7	430
BASE 180 JOIN		H 3 cm W 178 cm D 45 cm Kg 8 m3 0,05 pack.qty. 1	WHITE.LAC	9000.403989			0,05	8	440
MOVE			finishes	product code	package code	pack. qty	m3	kg	PLN
MOVE TV STAND 203/110		H 32 cm W 203/110 cm D 35 cm Kg 23 m3 0,07 pack.qty. 1	WALNUT.VEN/ WHITE.LAC	9003.639180			0,07	24	1540
			WALNUT.VEN/ GREY.LAC	9003.638244			0,07	24	1540
			WHITE.LAC/ PLYWOOD	9000.639197			0,07	23	1540
			CONCRETE.MEL/ BLACK.LAC	9000.639784			0,07	24	1540

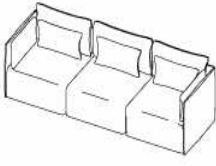



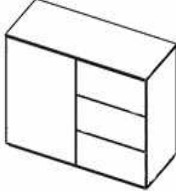
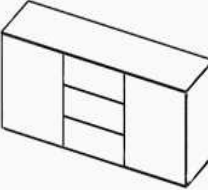
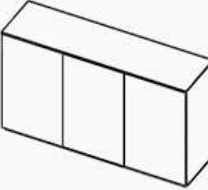



TV STANDS									
NARA			finishes	product code	package code	pack. qty	m3	kg	PLN
NARA TV STAND LOW		H 52 cm W 175 cm D 51 cm Kg 64 m3 0,17 pack.qty. 2	WALNUT.MEL/ BLACK.LAC	9500.640117	9000.640148	1	0,16	44	2960
					9000.640094	1	0,00	20	
			CONCRETE.MEL/ BLACK.LAC	9500.640070	9000.640087	1	0,16	41	2690
					9000.640094	1	0,00	20	
NINA			finishes	product code	package code	pack. qty	m3	kg	PLN
NINA TV STAND		H 59 cm W 140 cm D 42 cm Kg 37 m3 0,12 pack.qty. 1	WALNUT.VEN/ BLACK.LAC	9003.640155			0,12	42	2200
			LIGHT OAK.VEN/ WHITE.LAC	9003.639555			0,12	42	2200
			LIGHT OAK.VEN/ BLACK.LAC	9003.639548			0,12	42	2200
TRIVIA			finishes	product code	package code	pack. qty	m3	kg	PLN
TRIVIA TV STAND 140		H 56 cm W 140 cm D 45 cm Kg 45 m3 0,09 pack.qty. 2	LIGHT OAK.VEN/ BLACK METAL	9500.640162					2290
VERONE			finishes	product code	package code	pack. qty	m3	kg	PLN
VERONE TV STAND 180		H 38 cm W 180 cm D 38 cm Kg 39 m3 0,08 pack.qty. 2	LIGHT OAK.VEN/ WHITE.LAC	9500.639920	9003.639937	1	0,03	13	1390
					9003.639944	1	0,06	27	
			LIGHT OAK.VEN/ BLACK.LAC	9500.639951	9003.639968	1	0,03	13	1390
					9003.639975	1	0,06	27	
			CONCRETE.MEL/ BLACK.LAC	9500.640100	9000.640124	1	0,03	13	1390
					9000.640131	1	0,06	25	



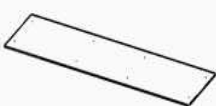

SOFAS

BRAND	DUNE		finishes	product code	package code	pack. qty	m3	kg	PLN
DUNE SOFA NO ARMS		H 84/68 cm W 80 cm D 90 cm Kg 16 m3 0,00 pack.qty. 1	CREME	9000.170812		0,00	17		2200
			LIGHT GREY	9000.170911		0,00	17		2200
			ANTHRACITE	9000.170867		0,00	17		2200
DUNE SOFA W/ LEFT ARM		H 84/68 cm W 90 cm D 90 cm Kg 27 m3 0,00 pack.qty. 1	CREME	9000.170799		0,00	27		2800
			LIGHT GREY	9000.170898		0,00	27		2800
			ANTHRACITE	9000.170843		0,00	27		2800
DUNE SOFA W/ RIGHT ARM		H 84/68 cm W 90 cm D 90 cm Kg 27 m3 0,00 pack.qty. 1	CREME	9000.170805		0,00	32		2800
			LIGHT GREY	9000.170904		0,00	32		2800
			ANTHRACITE	9000.170850		0,00	32		2800
DUNE SOFA 2 SEATERS		H 84/68 cm W 180 cm D 90 cm Kg 59 m3 0,00 pack.qty. 2	CREME	9500.170829					5600
			LIGHT GREY	9500.170928					5600
			ANTHRACITE	9500.170874					5600
DUNE SOFA 3 SEATERS		H 84/68 cm W 260 cm D 90 cm Kg 76 m3 0,00 pack.qty. 3	CREME	9500.170836					7800
			LIGHT GREY	9500.170935					7800
			ANTHRACITE	9500.170881					7800

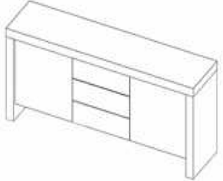
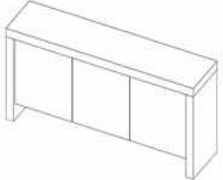
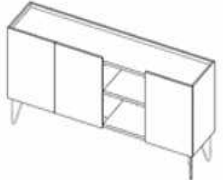

SIDEBOARDS									
BRAND	ALBI		finishes	product code	package code	pack. qty	m3	kg	PLN
ALBI SIDEBOARD 190		H 81 cm W 190 cm D 45 cm Kg 72 m3 0,15 pack.qty. 3	WALNUT.VEN/ BLACK METAL	9500.405631	9003.405648	1	0,06	27	4380
					9003.405655	1	0,05	24	
					9000.405662	1	0,04	21	
			LIGHT OAK.VEN/ WHITE METAL	9500.405679	9003.405686	1	0,06	28	4380
					9003.405693	1	0,05	24	
					9000.405709	1	0,04	21	
			LIGHT OAK.VEN/ BLACK METAL	9500.407147	9003.405686	1	0,06	28	4380
					9003.405693	1	0,05	24	
					9000.405662	1	0,04	21	
		CONCRETE.MEL/ BLACK METAL	9500.407116	9000.407123	1	0,06	25	4380	
				9000.407130	1	0,05	22		
				9000.405662	1	0,04	21		
EDGE			finishes	product code	package code	pack. qty	m3	kg	PLN
EDGE SIDEBOARD 200		H 76 cm W 200 cm D 42 cm Kg 63 m3 0,17 pack.qty. 3	WHITE.LAC/ WALNUT.VEN	9500.621680	9003.621680	1	0,06	23	3850
					9000.621796	1	0,08	30	
					9000.621338	1	0,03	11	
			WHITE.LAC/ OAK.VEN	9500.621697	9003.621697	1	0,06	23	3850
					9000.621796	1	0,08	30	
					9000.621338	1	0,03	11	
JOIN			finishes	product code	package code	pack. qty	m3	kg	PLN
JOIN 120H2 - BASE		H 84 cm W 120 cm D 50 cm Kg 74 m3 0,25 pack.qty. 4	WHITE.LAC/ WALNUT.VEN	9500.404283					3640
			WHITE.LAC/ OAK.VEN	9500.404276					3640
			WHITE.LAC	9500.404269					3640
JOIN 180H1 - BASE		H 84 cm W 180 cm D 50 cm Kg 107 m3 0,36 pack.qty. 5	WHITE.LAC/ WALNUT.VEN	9500.404405					4790
			WHITE.LAC/ OAK.VEN	9500.404399					4790
			WHITE.LAC	9500.404382					4790
JOIN 180H2 - BASE		H 84 cm W 180 cm D 50 cm Kg 103 m3 0,34 pack.qty. 5	WHITE.LAC/ WALNUT.VEN	9500.405143					3940
			WHITE.LAC/ OAK.VEN	9500.405136					3940
			WHITE.LAC	9500.405129					3940
KIT A 120 HIGH JOIN 2 DOORS		H 80 cm W 120 cm D 49 cm Kg 57 m3 0,15 pack.qty. 2	WHITE.LAC	9500.403231					2020

SIDEBOARDS

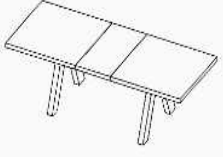
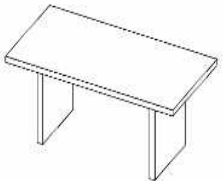
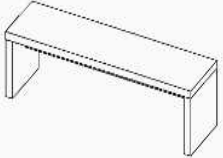

JOIN		finishes	product code	package code	pack. qty	m3	kg	PLN
JOIN KIT A 120 HIGH 1 DOOR + 3 DRAWERS		H 80 cm W 120 cm D 49 cm Kg 61 m3 0,18 pack.qty. 2	WHITE.LAC	9500.403248				2870
KIT A 120 HIGH JOIN 6 DRAWERS		H 80 cm W 120 cm D 49 cm Kg 65 m3 0,20 pack.qty. 3	WHITE.LAC	9500.403361				3720
KIT B 60 HIGH JOIN 1DOOR		H 80 cm W 60 cm D 49 cm Kg 27 m3 0,08 pack.qty. 1	WHITE.LAC	9000.403118		0,08	27	990
KIT B 40 HIGH JOIN 1DOOR		H 80 cm W 41 cm D 49 cm Kg 19 m3 0,05 pack.qty. 1	WHITE.LAC	9000.403309		0,05	20	850
TOP 120 JOIN		H 1 cm W 120 cm D 50 cm Kg 7 m3 0,03 pack.qty. 1	WALNUT.VEN OAK.VEN WHITE.LAC	9003.403712 9003.403668 9000.403767		0,03	8	400 400 400
TOP 160 JOIN		H 1 cm W 160 cm D 50 cm Kg 10 m3 0,04 pack.qty. 1	WALNUT.VEN OAK.VEN WHITE.LAC	9003.403729 9003.403675 9000.403774		0,04	10	460 460 460
TOP 180 JOIN		H 1 cm W 180 cm D 50 cm Kg 10 m3 0,05 pack.qty. 1	WALNUT.VEN OAK.VEN WHITE.LAC	9003.403736 9003.403682 9000.403781		0,05	11	490 490 490
BASE 120 JOIN		H 3 cm W 118 cm D 45 cm Kg 5 m3 0,04 pack.qty. 1	WHITE.LAC	9000.403965		0,04	6	370

SIDEBOARDS											
JOIN			finishes	product code	package code	pack. qty	m3	kg	PLN		
BASE 160 JOIN		H 3 cm W 158 cm D 45 cm Kg 7 m3 0,05 pack.qty. 1	WHITE.LAC	9000.403972			0,05	7	430		
BASE 180 JOIN		H 3 cm W 178 cm D 45 cm Kg 8 m3 0,05 pack.qty. 1	WHITE.LAC	9000.403989			0,05	8	440		
KOBE			finishes	product code	package code	pack. qty	m3	kg	PLN		
KOBE SIDEBOARD 2 DOORS 3 DRAWERS		H 79 cm W 188 cm D 45 cm Kg 75 m3 0,31 pack.qty. 3	WALNUT.MEL/ BLACK.LAC	9500.407345	9000.407352	1	0,12	22	3760		
					9000.402159	1	0,10	29			
					9000.407369	1	0,10	25			
					CONCRETE.MEL/ BLACK.LAC	9500.402135	9000.402142	1	0,12	21	3760
							9000.402159	1	0,10	29	
							9000.402166	1	0,10	23	
KOBE SIDEBOARD 3 DOORS		H 79 cm W 188 cm D 45 cm Kg 63 m3 0,30 pack.qty. 2	WALNUT.MEL/ BLACK.LAC	9500.407376	9000.407383	1	0,19	37	3360		
					9000.405051	1	0,11	26			
					CONCRETE.MEL/ BLACK.LAC	9500.400308	9000.400308	1	0,16	35	3360
							9000.400315	1	0,08	25	
NINA			finishes	product code	package code	pack. qty	m3	kg	PLN		
NINA SIDEBOARD		H 83 cm W 180 cm D 42 cm Kg 74 m3 0,27 pack.qty. 2	WALNUT.VEN/ BLACK.LAC	9500.407314	9003.407321	1	0,19	40	2970		
					9003.407338	1	0,09	34			
					LIGHT OAK.VEN/ WHITE.LAC	9500.404160	9000.404177	1	0,19	41	2970
							9003.404153	1	0,09	35	
					LIGHT OAK.VEN/ BLACK.LAC	9500.404139	9000.404146	1	0,19	40	2970
							9003.404153	1	0,09	35	
NINA CUPBOARD		H 147 cm W 100 cm D 42 cm Kg 84 m3 0,20 pack.qty. 3	WALNUT.VEN/ BLACK.LAC	9500.407284	9000.407291	1	0,09	28	2920		
					9000.407031	1	0,05	25			
					9003.407307	1	0,06	31			
					LIGHT OAK.VEN/ WHITE.LAC	9500.406973	9000.406980	1	0,09	29	2920
							9000.406997	1	0,05	26	
							9003.407000	1	0,06	31	
					LIGHT OAK.VEN/ BLACK.LAC	9500.407017	9000.407024	1	0,09	28	2920
							9000.407031	1	0,05	25	
				9003.407000	1	0,06	31				
VINY			finishes	product code	package code	pack. qty	m3	kg	PLN		
VINY SIDEBOARD		H 80 cm W 100 cm D 42 cm Kg 36 m3 0,07 pack.qty. 1	OAK.VEN	9003.407093			0,07	36	1790		
			OAK.VEN/ BLACK.LAC	9003.407109				0,07	36	1690	



DINING TABLES

APEX		finishes	product code	package code	pack. qty	m3	kg	PLN	
APEX DINING TABLE 200		H 76 cm W 200 cm D 100 cm Kg 61 m3 0,22 pack.qty. 2	CONCRETE.MEL/ BLACK.LAC	9500.612893	9000.612893	1	0,15	28	3120
					9000.612831	1	0,07	33	
APEX DINING TABLE 200 EXTENDIBLE		H 76 cm W 250/200 cm D 100 cm Kg 77 m3 0,28 pack.qty. 3	CONCRETE.MEL/ BLACK.LAC	9500.613173	9000.612817	1	0,17	37	4470
					9000.612831	1	0,07	33	
					9000.613173	1	0,04	8	
DETROIT		finishes	product code	package code	pack. qty	m3	kg	PLN	
DETROIT DINING TABLE 160		H 75 cm W 160 cm D 80 cm Kg 35 m3 0,19 pack.qty. 1	CONCRETE.MEL/ BLACK.LAC	9000.613494		0,19	35	1620	
DETROIT BENCH 140		H 43 cm W 140 cm D 38 cm Kg 15 m3 0,10 pack.qty. 1	CONCRETE.MEL/ BLACK.LAC	9000.130663		0,10	16	690	
DRIFT		finishes	product code	package code	pack. qty	m3	kg	PLN	
DRIFT DINING TABLE 180		H 75 cm W 180 cm D 91 cm Kg 40 m3 0,15 pack.qty. 2	WALNUT.VEN/ BLACK METAL	9500.614118	9000.614095	1	0,06	15	2990
					9003.614125	1	0,09	25	
			LIGHT OAK.VEN/ BLACK METAL	9500.614088	9000.614095	1	0,06	15	2990
					9003.614101	1	0,09	26	
DRIFT DINING TABLE 200		H 75 cm W 200 cm D 100 cm Kg 46 m3 0,17 pack.qty. 2	WALNUT.VEN/ BLACK METAL	9500.614422	9000.614439	1	0,08	16	4290
					9003.614446	1	0,09	31	
			LIGHT OAK.VEN/ BLACK METAL	9500.614453	9000.614439	1	0,08	16	4290
					9003.614507	1	0,09	31	

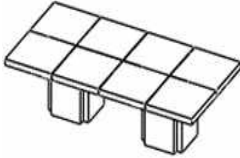
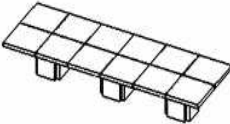
DINING TABLES

DUSK		finishes	product code	package code	pack. qty	m3	kg	PLN			
DUSK 130		H 75 cm W 130 cm D 130 cm Kg 69 m3 0,32 pack.qty. 2	CHOCOLATE.VEN	9500.620904	9003.620911	1	0,18	32	4390		
DUSK 150		H 75 cm W 150 cm D 150 cm Kg 77 m3 0,36 pack.qty. 2	CHOCOLATE.VEN	9500.620928	9003.620911	1	0,18	32	5240		
DUSK 002		H 75 cm W 262 cm D 130 cm Kg 140 m3 0,67 pack.qty. 4	CHOCOLATE.VEN	9500.613203	9003.620911	2	0,18	32	8770		
DUSK 003		H 75 cm W 392 cm D 130 cm Kg 211 m3 1,01 pack.qty. 6	CHOCOLATE.VEN	9500.613210	9003.620911	3	0,18	32	13150		





DINING TABLES

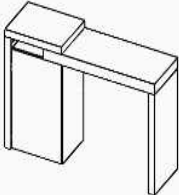

BRAND		LAGO		finishes	product code	package code	pack. qty	m3	kg	PLN	
LAGO DINING TABLE 180		H 75 cm W 180 cm D 100 cm Kg 51 m3 0,04 pack.qty. 1	LIGHT OAK.VEN	9003.614842				0,04	51	2990	
			WALNUT.VEN	9003.614835				0,04	50	2990	
BRAND		SHADOW		finishes	product code	package code	pack. qty	m3	kg	PLN	
SHADOW DINING TABLE 180/240 EXTENDABLE		H 75 cm W 240/180 cm D 100 cm Kg 66 m3 0,15 pack.qty. 2	WALNUT.VEN/ BLACK.LAC	9500.614750	9000.614736		1	0,07	22	5660	
						9003.614767		1	0,08	46	
			CONCRETE.MEL/ BLACK.LAC	9500.614729	9000.614736		1	0,07	22	5660	
						9000.614743		1	0,08	46	

BAR TABLES

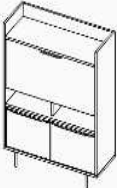



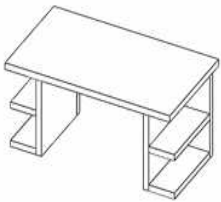

BRAND	ROLL	finishes	product code	package code	pack. qty	m3	kg	PLN	
ROLL ROTATING BAR TABLE		H 99 cm	LIGHT OAK.MEL/ WHITE.LAC	9500.970016	9000.970023	1	0,07	36	1890
		W 110 cm			9000.970030	1	0,04	14	
		D 50 cm	LIGHT OAK.MEL/ BLACK.LAC	9500.970047	9000.970054	1	0,07	35	1890
		Kg 49 m3 0,12 pack.qty. 2			9000.970030	1	0,04	14	

DESKS

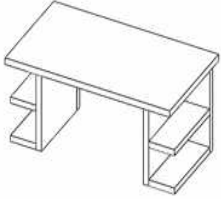



CITY		finishes	product code	package code	pack. qty	m3	kg	PLN	
CITY		H 78 cm W 130 cm D 50 cm Kg 30 m3 0,09 pack.qty. 2	WALNUT.VEN/ BLACK METAL	9500.053856	9000.053863	1	0,04	8	2190
					9003.053825	1	0,05	22	
			LIGHT OAK.VEN/ BLACK METAL	9500.053955	9000.053863	1	0,04	8	2190
					9003.053962	1	0,05	22	
DETROIT		finishes	product code	package code	pack. qty	m3	kg	PLN	
DETROIT		H 82 cm W 119 cm D 35 cm Kg 31 m3 0,16 pack.qty. 2	CONCRETE.MEL/ BLACK.LAC	9500.052835	9000.052835	1	0,07	14	1670
					9000.052842	1	0,08	17	
FLOW		finishes	product code	package code	pack. qty	m3	kg	PLN	
FLOW		H 75 cm W 140 cm D 75 cm Kg 16 m3 0,25 pack.qty. 2	OAK.VEN/ BLACK METAL	9500.053221	9003.053184	1	0,07	15	1490
					9000.053207	1	0,18	2	
			WHITE.LAC/ PLYWOOD/ BLACK METAL	9500.053214	9000.053177	1	0,07	15	1330
					9000.053207	1	0,18	2	
			CONCRETE.MEL/ BLACK METAL	9500.054051	9000.054068	1	0,07	13	1330
					9000.053207	1	0,18	2	
FOCUS		finishes	product code	package code	pack. qty	m3	kg	PLN	
FOCUS		H 109 cm W 110 cm D 42 cm Kg 76 m3 0,18 pack.qty. 3	WHITE.LAC/ WALNUT.VEN	9500.054099	9000.052606	1	0,05	24	3290
					9003.054105	1	0,07	23	
					9000.052620	1	0,05	18	
			WHITE.LAC/ OAK.VEN	9500.052606	9000.052606	1	0,05	24	3290
					9000.052613	1	0,07	23	
					9000.052620	1	0,05	18	
			WHITE.LAC	9500.054112	9000.052606	1	0,05	24	3290
					9000.054129	1	0,07	23	
					9000.052620	1	0,05	18	
LIME		finishes	product code	package code	pack. qty	m3	kg	PLN	
LIME		H 138 cm W 104 cm D 40 cm Kg 76 m3 0,13 pack.qty. 3	OAK.VEN/ BLACK.LAC	9500.053276	9003.053283	1	0,06	28	3690
					9000.053290	1	0,03	15	
					9003.053306	1	0,05	19	
LOFT		finishes	product code	package code	pack. qty	m3	kg	PLN	
LOFT		H 89 cm W 126 cm D 72 cm Kg 25 m3 0,06 pack.qty. 1	OAK.VEN/ BLACK.LAC	9003.053481			0,06	25	2310

DESKS									
BRAND	MITCH		finishes	product code	package code	pack. qty	m3	kg	PLN
MITCH		H 113 cm W 130 cm D 50 cm Kg 46 m3 0,10 pack.qty. 2	LIGHT OAK.MEL/ WHITE.LAC	9500.054457	9000.054471	1	0,06	31	1300
					9000.054464	1	0,03	15	
			LIGHT OAK.MEL/ BLACK.LAC	9500.054488	9000.054495	1	0,06	31	1300
					9000.054464	1	0,03	15	
MULTI			finishes	product code	package code	pack. qty	m3	kg	PLN
MULTI TRESTLES 160		H 77 cm W 160 cm D 90 cm Kg 23 m3 0,24 pack.qty. 2	WALNUT.VEN/ CHROME METAL	9500.611124	9003.619762	1	0,07	21	1920
					9000.659096	1	0,16	2	
			OAK.VEN/ CHROME METAL	9500.620836	9003.612220	1	0,07	21	1920
					9000.659096	1	0,16	2	
			WHITE.LAC/ METAL CHROME	9500.611230	9000.619083	1	0,07	21	1920
					9000.659096	1	0,16	2	
			WALNUT.VEN/ BLACK METAL	9500.613777	9003.619762	1	0,07	21	1920
					9000.053207	1	0,18	2	
		OAK.VEN/ BLACK METAL	9500.613760	9003.612220	1	0,07	21	1920	
				9000.053207	1	0,18	2		
		WHITE.LAC/ BLACK METAL	9500.613784	9000.619083	1	0,07	21	1920	
				9000.053207	1	0,18	2		
		CONCRETE.MEL/ BLACK METAL	9500.613982	9000.613968	1	0,07	19	1920	
				9000.053207	1	0,18	2		
MULTI TRESTLES 180		H 77 cm W 180 cm D 90 cm Kg 25 m3 0,29 pack.qty. 2	WALNUT.VEN/ CHROME METAL	9500.611360	9003.619724	1	0,12	23	2040
					9000.659096	1	0,16	2	
			OAK.VEN/ CHROME METAL	9500.621031	9003.612237	1	0,12	23	2040
					9000.659096	1	0,16	2	
			WHITE.LAC/ METAL CHROME	9500.611452	9000.611452	1	0,12	23	2040
					9000.659096	1	0,16	2	
			WALNUT.VEN/ BLACK METAL	9500.613814	9003.619724	1	0,12	23	2040
		9000.053207	1	0,18	2				
		OAK.VEN/ BLACK METAL	9500.613807	9003.612237	1	0,12	23	2040	
				9000.053207	1	0,18	2		
		WHITE.LAC/ BLACK METAL	9500.613821	9000.611452	1	0,12	23	2040	
				9000.053207	1	0,18	2		
MULTI STORAGE 160		H 75 cm W 160 cm D 90 cm Kg 58 m3 0,24 pack.qty. 3	WALNUT.VEN/ WHITE.LAC	9500.620171	9003.619762	1	0,07	21	3150
					9000.612213	1	0,08	19	
					9000.612305	1	0,08	18	
			OAK.VEN/ WHITE.LAC	9500.620188	9003.612220	1	0,07	21	3150
					9000.612213	1	0,08	19	
					9000.612305	1	0,08	18	
		WHITE.LAC	9500.612305	9000.619083	1	0,07	21	3150	
				9000.612213	1	0,08	19		
				9000.612305	1	0,08	18		

DESKS

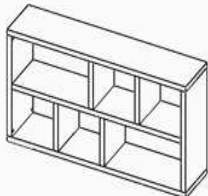
MULTI			finishes	product code	package code	pack. qty	m3	kg	PLN
MULTI STORAGE 180		H 75 cm W 180 cm D 90 cm Kg 60 m3 0,29 pack.qty. 3	WALNUT.VEN/ WHITE.LAC	9500.620225	9003.619724	1	0,12	23	3270
				9000.612213	1	0,08	19		
				9000.612305	1	0,08	18		
			OAK.VEN/ WHITE.LAC	9500.620232	9003.612237	1	0,12	23	3270
				9000.612213	1	0,08	19		
				9000.612305	1	0,08	18		
WHITE.LAC	9500.620881	9000.611452	1	0,12	23	3270			
	9000.612213	1	0,08	19					
	9000.612305	1	0,08	18					
OLIVAL			finishes	product code	package code	pack. qty	m3	kg	PLN
OLIVAL DESK		H 90 cm W 90 cm D 42 cm Kg 46 m3 0,13 pack.qty. 2	LIGHT OAK.MEL/ WHITE.LAC	9500.054518	9000.054525	1	0,07	25	2490
					9000.054532	1	0,06	22	
PLY			finishes	product code	package code	pack. qty	m3	kg	PLN
PLY		H 81 cm W 120 cm D 60 cm Kg 20 m3 0,09 pack.qty. 1	LIGHT OAK.VEN/ BLACK METAL	9003.054082			0,09	16	1810
PRADO			finishes	product code	package code	pack. qty	m3	kg	PLN
PRADO		H 75 cm W 130 cm D 60 cm Kg 46 m3 0,13 pack.qty. 3	WHITE.LAC/ WHITE METAL	9500.052545	9000.052514	1	0,05	19	1780
				9000.052521	1	0,05	25		
				9000.052545	1	0,03	3		
TANGO			finishes	product code	package code	pack. qty	m3	kg	PLN
TANGO DESK 160		H 76 cm W 264/159 cm D 159/48 cm Kg 89 m3 0,13 pack.qty. 3	LIGHT OAK.MEL/ WHITE.LAC	9500.054549					3790
VOLGA			finishes	product code	package code	pack. qty	m3	kg	PLN
VOLGA		H 88 cm W 90 cm D 60 cm Kg 19 m3 0,06 pack.qty. 1	BLACK.LAC/ WALNUT.VEN	9003.052927			0,06	20	1660
				9003.052811			0,06	20	1660
				9003.052965			0,06	20	1660
				9000.054075			0,08	20	1660

CONSOLES

BERLIN		finishes	product code	package code	pack. qty	m3	kg	PLN	
BERLIN CONSOLE 150		H 83 cm W 150 cm D 34 cm Kg 35 m3 0,13 pack.qty. 1	WALNUT.VEN	9003.322570		0,13	36	1950	
			OAK.VEN	9003.322563		0,13	37	1950	
			WHITE.LAC/ PLYWOOD	9000.322556		0,13	34	1560	
			WHITE.LAC	9000.322549		0,13	34	1560	
			CONCRETE.MEL	9000.322587		0,13	37	1560	
GLEAM		finishes	product code	package code	pack. qty	m3	kg	PLN	
GLEAM CONSOLE 120 MARBLE		H 76 cm W 120 cm D 40 cm Kg 41 m3 0,49 pack.qty. 2	WHITE MARBLE/ CHROME METAL	9500.629495	9000.627279	1	0,10	32	3710
					9000.629754	1	0,39	9	
			BLACK MARBLE/ CHROME METAL	9500.629501	9000.627286	1	0,10	32	3710
					9000.629754	1	0,39	9	
			GREEN MARBLE/ CHROME METAL	9500.629518	9000.627293	1	0,10	32	3710
					9000.629754	1	0,39	9	
			WHITE MARBLE/ BLACK METAL	9500.628924	9000.627279	1	0,10	32	3210
		9000.628856	1	0,39	9				
		BLACK MARBLE/ BLACK METAL	9500.628900	9000.627286	1	0,10	32	3210	
				9000.628856	1	0,39	9		
		GREEN MARBLE/ BLACK METAL	9500.628917	9000.627293	1	0,10	32	3210	
				9000.628856	1	0,39	9		
GLEAM CONSOLE 120 MARBLE KIT		H 76 cm W 120 cm D 40 cm Kg 37 m3 0,16 pack.qty. 2	WHITE MARBLE/ CHROME METAL	9500.630255	9000.627279	1	0,10	32	3540
					9000.630057	1	0,06	5	
			BLACK MARBLE/ CHROME METAL	9500.630279	9000.627286	1	0,10	32	3540
					9000.630057	1	0,06	5	
			GREEN MARBLE/ CHROME METAL	9500.630293	9000.627293	1	0,10	32	3540
					9000.630057	1	0,06	5	
			WHITE MARBLE/ BLACK METAL	9500.630248	9000.627279	1	0,10	32	3070
		9000.630040	1	0,06	5				
		BLACK MARBLE/ BLACK METAL	9500.630262	9000.627286	1	0,10	32	3070	
				9000.630040	1	0,06	5		
		GREEN MARBLE/ BLACK METAL	9500.630286	9000.627293	1	0,10	32	3070	
				9000.630040	1	0,06	5		
GLEAM CONSOLE 120		H 76 cm W 120 cm D 40 cm Kg 16 m3 0,41 pack.qty. 2	WALNUT.VEN/ CHROME METAL	9500.629488	9003.628771	1	0,02	7	2200
					9000.629754	1	0,39	9	
			OAK.VEN/ CHROME METAL	9500.629471	9003.626555	1	0,02	7	2200
					9000.629754	1	0,39	9	
			WALNUT.VEN/ BLACK METAL	9500.628863	9003.628771	1	0,02	7	1700
		9000.628856	1	0,39	9				
		OAK.VEN/ BLACK METAL	9500.628870	9003.626555	1	0,02	7	1700	
				9000.628856	1	0,39	9		

CHAIRS

SALLY

finishes	product code	package code	pack. qty	m3	kg	PLN
----------	--------------	--------------	-----------	----	----	-----

SALLY CHAIRS (2)



H 87 cm
W 51 cm
D 49 cm
Kg 12
m3 0,33
pack.qty. 1

OAK.VEN	SALY.130700			0,33	12	2200
---------	-------------	--	--	------	----	-------------

set of 2 chairs / delivered assembled

SAND

finishes	product code	package code	pack. qty	m3	kg	PLN
----------	--------------	--------------	-----------	----	----	-----

SAND CHAIR (2)



H 73 cm
W 52 cm
D 44 cm
Kg 12
m3 0,00
pack.qty. 1

BLACK	SAND.002			0,00	12	4360
-------	----------	--	--	------	----	-------------















SAND CHAIR (2)









H 73 cm
W 52 cm
D 44 cm
Kg 12
m3 0,00
pack.qty. 1

BEECH.VEN	SAND.001			0,00	12	3840
-----------	----------	--	--	------	----	-------------

set of 2 chairs / delivered assembled





BEDS									
FLOAT			finishes	product code	package code	pack. qty	m3	kg	PLN
FLOAT BED 150		H 31/81 cm W 180 cm D 216 cm Kg 58 m3 0,21 pack.qty. 2	WALNUT.VEN	9500.758478	9003.758478	1	0,13	20	3960
					9003.758485	1	0,08	38	
FLOAT BED 160		H 31/81 cm W 180 cm D 208 cm Kg 58 m3 0,20 pack.qty. 2	WALNUT.VEN	9500.757556	9003.757549	1	0,12	20	3960
					9003.757556	1	0,08	38	
FLOAT BED 160		H 31/81 cm W 180 cm D 208 cm Kg 58 m3 0,20 pack.qty. 2	WHITE.LAC	9500.759406	9000.759406	1	0,12	20	3960
					9000.758355	1	0,08	37	
FLOAT BED 180		H 31/81 cm W 200 cm D 208 cm Kg 61 m3 0,26 pack.qty. 3	WALNUT.VEN	9500.758720	9003.758720	1	0,16	22	4130
					9003.758737	1	0,05	20	
FLOAT BED 180		H 31/81 cm W 200 cm D 208 cm Kg 61 m3 0,26 pack.qty. 3			9003.758744	1	0,05	20	4130
			WHITE.LAC	9500.758799	9000.759413	1	0,16	22	
FLOAT BED 150 W/ SLATS		H 31/81 cm W 180 cm D 216 cm Kg 75 m3 0,35 pack.qty. 3	WALNUT.VEN	9500.758522	9003.758478	1	0,13	20	4870
					9003.758485	1	0,08	38	
FLOAT BED 150 W/ SLATS		H 31/81 cm W 180 cm D 216 cm Kg 75 m3 0,35 pack.qty. 3			9000.279164	1	0,14	18	4870
			WHITE.LAC	9500.758881	9000.759406	1	0,12	20	
FLOAT BED 160 W/ SLATS		H 31/81 cm W 180 cm D 208 cm Kg 77 m3 0,36 pack.qty. 3	WALNUT.VEN	9500.758843	9003.757549	1	0,12	20	4870
					9003.757556	1	0,08	38	
FLOAT BED 160 W/ SLATS		H 31/81 cm W 180 cm D 208 cm Kg 77 m3 0,36 pack.qty. 3			9000.279140	1	0,16	20	4870
			WHITE.LAC	9500.758881	9000.759406	1	0,12	20	
FLOAT BED 160 W/ SLATS		H 31/81 cm W 180 cm D 208 cm Kg 77 m3 0,36 pack.qty. 3			9000.758355	1	0,08	37	4870
					9000.279140	1	0,16	20	
FLOAT BED 180 W/ SLATS		H 31/81 cm W 200 cm D 208 cm Kg 84 m3 0,44 pack.qty. 4	WALNUT.VEN	9500.759673	9003.758720	1	0,16	22	5080
					9003.758737	1	0,05	20	
FLOAT BED 180 W/ SLATS		H 31/81 cm W 200 cm D 208 cm Kg 84 m3 0,44 pack.qty. 4			9003.758744	1	0,05	20	5080
			WHITE.LAC	9500.759680	9000.759413	1	0,16	22	
FLOAT BED 180 W/ SLATS		H 31/81 cm W 200 cm D 208 cm Kg 84 m3 0,44 pack.qty. 4			9000.279157	1	0,18	22	5080
					9000.758263	1	0,05	19	
FLOAT BED 180 W/ SLATS		H 31/81 cm W 200 cm D 208 cm Kg 84 m3 0,44 pack.qty. 4			9000.758287	1	0,05	20	5080
					9000.279157	1	0,18	22	
FLOAT HEADBOARD 150		H 70 cm W 180 cm D 8 cm Kg 20 m3 0,13 pack.qty. 1	WALNUT.VEN	9003.758478			0,13	20	1740
		mattress dimensions : 153x204 cm							

BEDS

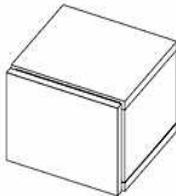

FLOAT		finishes	product code	package code	pack. qty	m3	kg	PLN	
FLOAT HEADBOARD 160		H 70 cm W 180 cm D 8 cm Kg 20 m3 0,12 pack.qty. 1	WALNUT.VEN	9003.757549		0,12	20	1740	
			WHITE.LAC	9000.759406		0,12	20	1740	
mattress dimensions : 160x200 cm									
FLOAT HEADBOARD 180		H 70 cm W 200 cm D 8 cm Kg 22 m3 0,16 pack.qty. 1	WALNUT.VEN	9003.758720		0,16	22	1820	
			WHITE.LAC	9000.759413		0,16	22	1820	
mattress dimensions : 180x200 cm									
FLOAT STRUCTURE 150		H 31 cm W 159 cm D 207 cm Kg 37 m3 0,08 pack.qty. 1	WALNUT.VEN	9003.758485		0,08	38	2220	
		mattress dimensions : 153x204 cm							
FLOAT STRUCTURE 160		H 31 cm W 167 cm D 203 cm Kg 37 m3 0,08 pack.qty. 1	WALNUT.VEN	9003.757556		0,08	38	2220	
			WHITE.LAC	9000.758355		0,08	37	2220	
mattress dimensions : 160x200 cm									
FLOAT STRUCTURE 180		H 31 cm W 186 cm D 207 cm Kg 39 m3 0,11 pack.qty. 2	WALNUT.VEN	9500.758744	9003.758737	1	0,05	20	2310
					9003.758744	1	0,05	20	
			WHITE.LAC	9500.758263	9000.758263	1	0,05	19	2310
					9000.758287	1	0,05	20	
mattress dimensions : 180x200 cm									
FLOAT MATTRESS SUPPORT 150		H 3 cm W 154 cm D 204 cm Kg 17 m3 0,14 pack.qty. 1	METAL/ WOOD	9000.279164		0,14	18	910	
FLOAT MATTRESS SUPPORT 160		H 3 cm W 160 cm D 200 cm Kg 19 m3 0,16 pack.qty. 1	METAL/ WOOD	9000.279140		0,16	20	910	

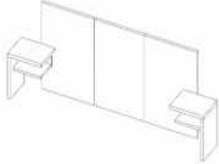
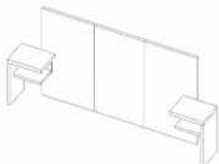
BEDS						
FLOAT			finishes	product code	package code	pack. m3 kg PLN qty
FLOAT MATTRESS SUPPORT 180		H 3 cm W 180 cm D 200 cm Kg 22 m3 0,18 pack.qty. 1	METAL/ WOOD	9000.279157		0,18 22 950

BEDROOM STORAGE

AURORA			finishes	product code	package code	pack. qty	m3	kg	PLN	
AURORA NIGHT TABLE WITH 2 DRAWERS		H 45 cm W 60 cm D 44 cm Kg 0 m3 0,15 pack.qty. 2	WALNUT.VEN	9500.758492	9003.758492	1	0,06	16	1700	
					9003.758614	1	0,09	10		
			WHITE.LAC	9500.310263	9000.310263	1	0,06	15	1700	
					9000.758621	1	0,09	10		
FLOAT			finishes	product code	package code	pack. qty	m3	kg	PLN	
FLOAT NIGHT TABLE 1 DRAWER		H 31 cm W 45 cm D 43 cm Kg 12 m3 0,04 pack.qty. 1	WALNUT.VEN	9003.759543			0,04	13	1280	
			WHITE.LAC	9000.759642				0,04	12	1010
 BRAND	HUGO			finishes	product code	package code	pack. qty	m3	kg	PLN
HUGO HEADBOARD 160		H 100 cm W 261 cm D 39 cm Kg 47 m3 0,16 pack.qty. 3	LIGHT OAK.MEL/ WHITE.LAC	9500.764295	9000.764264	1	0,05	17	2200	
					9000.764271	1	0,07	21		
					9000.764301	1	0,04	9		
			LIGHT OAK.MEL/ ANTHRACITE.LAC	9500.764257	9000.764264	1	0,05	17	2260	
					9000.764271	1	0,07	21		
					9000.764288	1	0,04	9		
HUGO HEADBOARD 180		H 100 cm W 281 cm D 39 cm Kg 49 m3 0,17 pack.qty. 3	LIGHT OAK.MEL/ WHITE.LAC	9500.764332	9000.764264	1	0,05	17	2270	
					9000.764271	1	0,07	21		
					9000.764349	1	0,05	11		
			LIGHT OAK.MEL/ ANTHRACITE.LAC	9500.764318	9000.764264	1	0,05	17	2380	
					9000.764271	1	0,07	21		
					9000.764325	1	0,05	11		
HUGO CHEST OF 5 DRAWERS		H 113 cm W 63 cm D 50 cm Kg 53 m3 0,16 pack.qty. 2	LIGHT OAK.MEL	9500.764394	9000.764400	1	0,09	29	3350	
					9000.764417	1	0,07	25		
HUGO CHEST OF 5 DRAWERS W/ DOOR		H 113 cm W 113 cm D 50 cm Kg 82 m3 0,21 pack.qty. 3	LIGHT OAK.MEL/ WHITE.LAC	9500.764479	9000.764455	1	0,09	32	4290	
					9000.764417	1	0,07	25		
					9000.764486	1	0,05	27		
			LIGHT OAK.MEL/ ANTHRACITE.LAC	9500.764448	9000.764455	1	0,09	32	4340	
					9000.764417	1	0,07	25		
					9000.764462	1	0,05	27		

BEDROOM STORAGE

BRAND	HUGO		finishes	product code	package code	pack. qty	m3	kg	PLN
HUGO CHEST OF 5 DRAWERS W/ HANGER		H 113 cm W 63 cm D 50 cm Kg 59 m3 0,16 pack.qty. 2	LIGHT OAK.MEL	9500.764424	9000.764431	1	0,09	35	3990
					9000.764417	1	0,07	25	
HUGO VANITY		H 139 cm W 105 cm D 42 cm Kg 28 m3 0,09 pack.qty. 1	LIGHT OAK.MEL/ ANTHRACITE.LAC	9000.980015			0,09	30	1780
			LIGHT OAK.MEL/ WHITE.LAC	9000.980022			0,09	31	1680

Conditions

Valid: from: 01/01/2023 to: 31/12/2024

Lead Time: 4-6 weeks

*** TemaHome reserves the right to change the information contained in this pricelist without any further notice.**

Claims Policy

All transport claims must be submitted in writing, within 5 working days of receipt of merchandise.

If the shipment is not delivered in accordance with the quantity, cartons, and number of packages shown on the bill of lading or the merchandise is freight damaged, do not accept the shipment until such shortages or damages are noted on the freight bill.

If you believe the merchandise is damaged due to freight handling, set it aside in its original packaging and contact our Customer Service Department.

Do not deduct for damaged and/or missing items. Do not discard damaged items without authorization.

All other claims should be sent in writing and as detailed as possible. A photograph of the damaged area of the product will be required.

Prior to the return of goods, the written claim must be submitted and authorized.

Automatic deductions on invoices are not accepted without prior authorization.

All claims will be reviewed and answered within 5 to 10 working days of the date of receipt.

Before making a claim, please ensure that one the following situations is not present:

Your customer is carefully following the assembly instructions. We will not replace components that are damaged as a result of bad mounting.

If your customer is claiming that the wood is darkening in certain spots or as a whole, please explain that the darkening of any wood product is a result of its exposure to daylight or sunlight (wood is a living material).

General Product Information

Product components consist in straight panels which are made up of the following raw materials:

- chipboard
 - Medium Density Fiberboard (MDF or fiber board)
 - honeycomb
 - veneer (cherry, oak*, beech* and walnut)
 - glue
 - varnish or paint
- * chocolate color is stained on oak veneer and wenge color is stained on beech veneer.

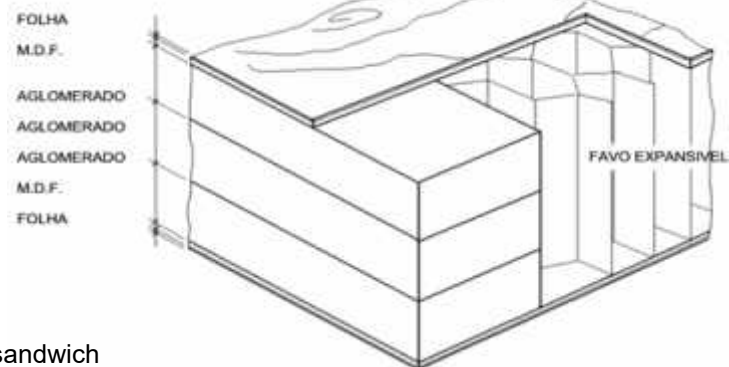

All 1.6 cm thick components are made of regular chipboard or particle board. Thicker components are made of sandwich construction with a solid chipboard frame. Additional cross bars are used for larger elements. The honeycomb inlay provides stability and strength to the products. The panels are then varnished or lacquered depending on the piece.

Wood is a living material and as such suffers changes caused by the environment. Sunlight and, especially, ultra violet light accelerate the darkening or lightening of wood depending on the veneer. This phenomenon is most evident in light woods. We recommend that during the first days of exposure to light, the objects placed on the furniture are moved around frequently to allow for the darkening/ lightening of wood to be even without causing lighter and darker spots.

TemaHome products are intended solely for residential use and are unsuitable for intensive use such as in restaurants, bars, etc.

Our varnish offers ISO standard resistance for household use.

Like other veneered / wooden products, our products are sensible to liquids. Normal resistance is a few minutes but if water is left on the furniture for a long period of time it will result in the absorption and expansion of the agglomerate.

The products are sensitive to high temperatures. Hot plates taken directly out of the oven can not be placed directly on the surface.

For the maintenance of the surfaces, normal furniture cleaning products that are non abrasive should be used. Clean with a damp cloth and avoid solvents.

TEMAHOME PORTUGAL S.A.
Factory - Tomar
Zona Industrial Tomar
2305 - 127 Tomar
Portugal

Tel.: (+351) 249 380 020
Fax: (+351) 249 380 029

TEMAHOME GROUP
Annecy - France
Tomar & Lisboa - Portugal
Wilmington, DE -USA

COPYRIGHT 2024 TEMAHOME
ALL RIGHTS RESERVED
Temahome reserves the right
to change any information in
this catalogue, including but
not limited to, discounting and/
or altering products, at any
time and without giving prior
notice.

Temahome is not responsible
for typographical or printing
errors.