

TENKSOM

one seat in the right direction



Vivole

Designed by Ashkan Heydari



Sustainability in focus

We select materials and develop designs with sustainability, disassembly, and recirculation in mind.



FSC®-certified

In all of our products, we use FSC®-certified wood - the mark of responsible forestry.



Detachable covers

All our products have detachable covers for easy maintenance.



Prioritizing recycled materials

Our fabrics are all made from or partly made from recycled materials.



All our fabrics are OEKO-TEX® certified. OEKO-TEX® is one of the world's best-known labels for textiles tested for harmful substances to ensure customer confidence and high product safety.



Warranty on frames

We offer a 10-year warranty on our frames, as we want to make sure that all our products have a prolonged lifespan.



Optimized for transport

Our designs and packaging are optimized to ensure minimized CO₂ emissions in relation to transport and storage.

Introduction

As consumers, we are all obligated to reevaluate our consumption habits. Our collective willingness to prioritize the purchase of products that we want to keep over time is crucial, as it is the most effective way to minimize resource consumption and pollution.

As a supplier of upholstered furniture, we are obligated to design and develop products with a long life cycle in mind. At the same time, materials must be selected and designs developed with sustainability, disassembly, and recirculation in mind.

Vivole is designed to honor the above principles without compromising functionality, comfort, quality, or aesthetics.

The first principal criteria to meet when designing and producing a meaningful sustainable product is to ensure that the product will have a degree of uniqueness, a convincing and attractive aesthetic and functional profile.

In terms of build, style and comfort, Vivole is designed to respect the above.











Vivole is distinguished by its uniquely soft and inviting appearance and is designed to have superior comfort and an ultimate lounge feeling. This is ensured by the large proportions and the deep seating, which combined with the large variety of different combinations, offers flexibility, enabling you to shape it into any living space.

At the heart of Vivole is an unwavering commitment to comfort and relaxation. With two distinct cushion shapes, the sofa can be adjusted to suit varying comfort needs, accommodating different body structures and situations. Moreover, we provide a curated selection of additional cushions, ensuring that you always have the ideal support.







Vivole is both comfortable and practical with its removable, washable covers. The design also makes it possible to easily replace individual parts in case they are damaged, or you just want to change the look by replacing the color of the cover or choice of fabric. Vivole comes with a 10 year warranty on the frame. Designed to have a long lifespan - in the interest of your economy and consumption of resources.





Give back to Nature

In addition to using FSC®-certified wood, we contribute to the balance of the global ecosystem by planting more than 10.000 trees every year to compensate for our consumption of wood.



The mark of
responsible forestry

Sustainability profile

Vivole is designed for a long life cycle, which is one of the primary intentions of our design philosophy.

- Strong and durable components in a design optimized for easy maintenance.
- All parts can be individually renewed if worn out or in case of damaging accidents.
- The detachable, washable covers are fitted with velcro that enable quick removal and precise reassembly, ensuring that the sofa remains presentable over time.
- We offer a 10-year warranty on our frames.

Optimized for transportation

The flat package design ensures minimized CO₂ emissions in relation to transport and storage, as it reduces the total volume of the items. Smaller packages also mean more convenient handling and thus less risk of damage during transport, as well as it makes it easier to install a sofa in, for instance, compact apartment buildings.

Materials

All materials are carefully selected in respect of overall quality and sustainability profile of the product.

- Which materials do we have available?
- How is it produced and with which environmental impact?
- Can the material be reused or upcycled?
- Which materials meet our expectations in terms of aesthetics, comfort, and durability?

Disassembly, recycling & waste management

The sofa is designed as individual components, which allow for separation of the sofa to ensure materials can be sorted into recyclable parts and waste.

The combinations

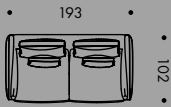

2,5 Seater



3 Seater

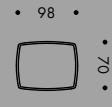

Footrest

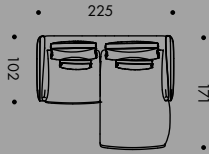

1,5 Seater + Chaise

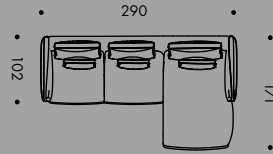

2,5 Seater + Chaise

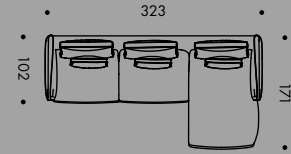

3 Seater + Chaise

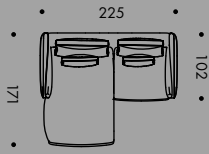

Chaise + 1,5 Seater

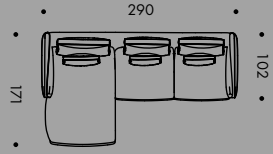

Chaise + 2,5 Seater

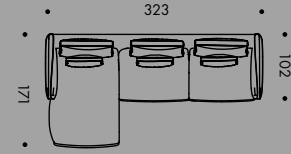

Chaise + 3 Seater

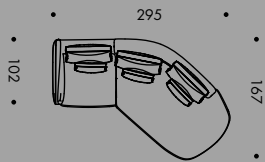

1,5 Seater + 45° Open-end

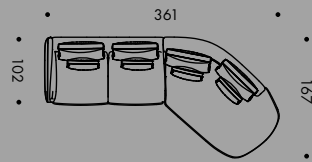

2,5 Seater + 45° Open-end

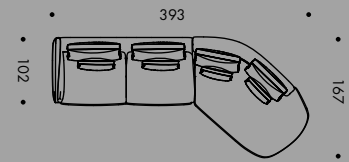

3 Seater + 45° Open-end

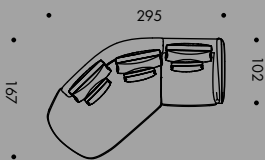

45° Open-end + 1,5 Seater

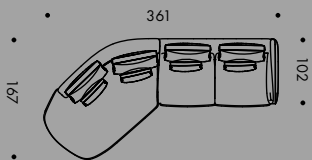

45° Open-end + 2,5 Seater

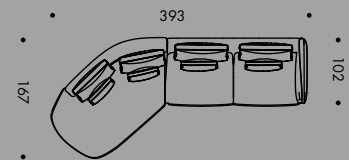

45° Open-end + 3 Seater

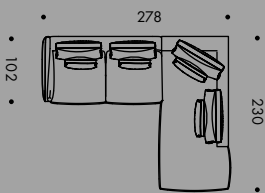

2,5 Seater + Open-end

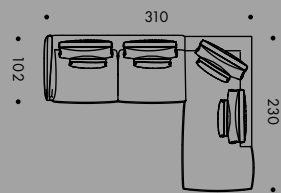

3 Seater + Open-end

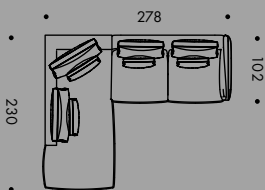

Open-end + 2,5 Seater

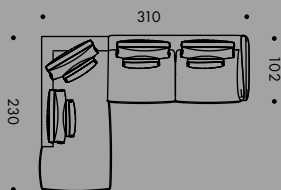

Open-end + 3 Seater

Tenksom fabric collection

All our products are exclusively crafted with OEKO-TEX® certified recycled fabrics, seamlessly blending elegance with a commitment to sustainability. This approach revitalizes discarded materials while contributing to a more sustainable future. Please visit our website or contact your local dealer to learn more about our fabric collection.

Scan the QR code or visit www.tenksom.com



Comfort

Vivole is based on a solid FSC®-certified finger-joint pinewood frame. The comfort is constructed to be simple with few materials. A no-zag spring base with an OEKO-TEX® high resilient foam core. Hypersoft foam and an OEKO-TEX® certified fiberfill create a soft topping.

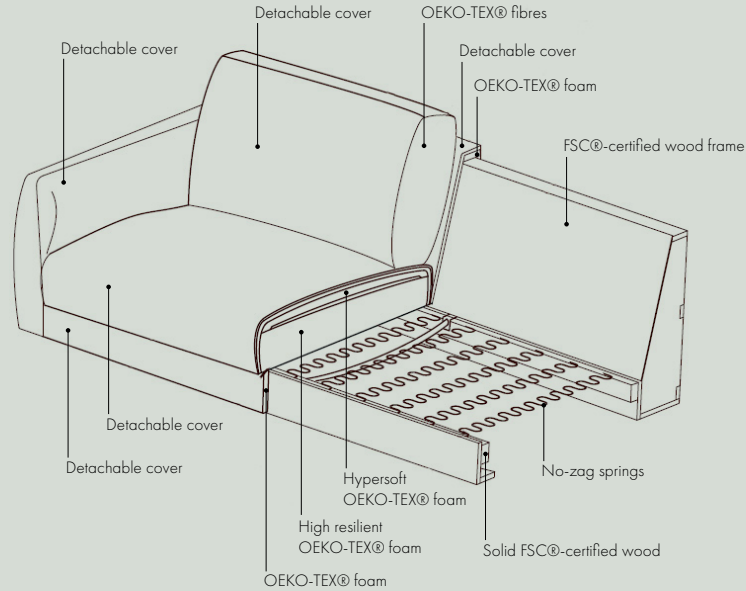

Envelope cushions

Detachable covers. OEKO-TEX® carded fibres and fibertex inner covers. Please note that Envelope cushions are optional extras.



50 x 50 cm



65 x 65 cm



40 x 60 cm



35 x 70 cm

Designed by
Ashkan Heydari



one seat in the right direction

www.tenksom.com

